

Radial Leaded PTC Devices

- The New Radial Leaded devices are designed to provide different products in the general applications with maximum 16 volts and a maximum 100-ampere short circuit rating.
- Agency Approval: UL/ CSA File #E201431
TÜV Certificate #R50103284



Polytronics Technology Corp
REGISTERED TO QS9000, TL9000,
ISO9001 (version 2000), and ISO 14001
CERTIFICATE NO. A8727 and A10971

ELECTRICAL CHARACTERISTICS

Part Number	I _{hold} (A)	I _{trip} (A)	V _{max} (Vdc)	I _{max} (A)	P _d Typ. (W)	Maximum Time To Trip		Resistance		Agency Approval
						Current (A)	Time (Sec.)	R _{min} (Ω)	R _{1max} (Ω)	
RLD16P250GF	2.5	4.7	16	100	1.0	12.5	5.0	0.0220	0.0530	UL/CSA/TÜV
RLD16P300GF	3.0	5.1	16	100	2.3	15.0	1.0	0.0380	0.0975	UL/CSA/TÜV
RLD16P400GF	4.0	6.8	16	100	2.4	20.0	1.7	0.0210	0.0600	UL/CSA/TÜV
RLD16P500GF	5.0	8.5	16	100	2.6	25.0	2.0	0.0150	0.0340	UL/CSA/TÜV
RLD16P600GF	6.0	10.2	16	100	2.8	30.0	3.3	0.0100	0.0280	UL/CSA/TÜV
RLD16P700GF	7.0	11.9	16	100	3.0	35.0	3.5	0.0077	0.0200	UL/CSA/TÜV
RLD16P800GF	8.0	13.6	16	100	3.0	40.0	5.0	0.0056	0.0175	UL/CSA/TÜV
RLD16P900GF	9.0	15.3	16	100	3.3	45.0	5.5	0.0047	0.0135	UL/CSA/TÜV
RLD16P1000GF	10.0	17.0	16	100	3.6	50.0	6.0	0.0040	0.0102	UL/CSA/TÜV
RLD16P1100GF	11.0	18.7	16	100	3.7	55.0	7.0	0.0037	0.0089	UL/CSA/TÜV
RLD16P1200GF	12.0	20.4	16	100	4.2	60.0	7.5	0.0033	0.0086	UL/CSA/TÜV
RLD16P1400GF	14.0	23.8	16	100	4.6	70.0	9.0	0.0026	0.0064	UL/CSA/TÜV

Note: I_{hold} = Hold current: maximum current device will pass without tripping in 23°C still air.

I_{trip} = Trip current: minimum current at which the device will trip in 23°C still air.

V_{max} = Maximum voltage device can withstand without damage at rated current (I_{max})

I_{max} = Maximum fault current device can withstand without damage at rated voltage (V_{max})

P_d = Power dissipated from device when in the tripped state at 23°C still air.

R_{min} = Minimum resistance of device in initial (un-soldered) state.

R_{1max} = Maximum resistance of device at 23°C measured one hour after tripping.

Caution: Operation beyond the specified rating may result in damage and possible arcing and flame.

Recognitions: UL, CSA, TUV recognized.

© Specifications are subject to change without notice.

07/17/2008

聚鼎科技股份有限公司 Polytronics Technology Corp.

新竹市科學工業園區工業東四路 24 號之一 24-1, Industry E.4th Rd. Science Park, Hsinchu, Taiwan. TEL:886-3-5643931 FAX:886-3-5644624
E-mail: pttc6368@ms22.hinet.net Http://www.pttc.com.tw



Radial Leaded PTC Devices

How to Select a Polymer PTC fuse:

- (1) Determine the following operating parameters for the circuits:
 - (A) Normal Operating Current (I hold)
 - (B) Maximum Circuit Voltage (V max)
 - (C) Maximum Interrupt Current (I max)
 - (D) Normal Operating Temperature (min°C/max°C)
- (2) Select the device form factor and dimension suitable for the application:
 - Surface Mount Device (SMD Series)
 - Radial Leaded Device (RLD Series)
 - Axial Leaded Strap Device (STD Series)
 - Other Custom-designed Device (Disc/Chip)
- (3) Compare the maximum ratings for V max and I max of the PTC device with the circuit in application and make sure that the circuit's requirement does not exceed the device ratings.
- (4) Check that the PTC device's trip time (time-to-trip) will protect the circuit.
- (5) Verify that the circuit operating temperatures are within the PTC device's normal operating temperature range.
- (6) Verify the performance and suitability of the chosen PTC device in the application.

07/17/2008

Radial Leaded PTC Devices

THERMAL DERATING CURVE FOR RLD FOR 16Vdc G SERIES

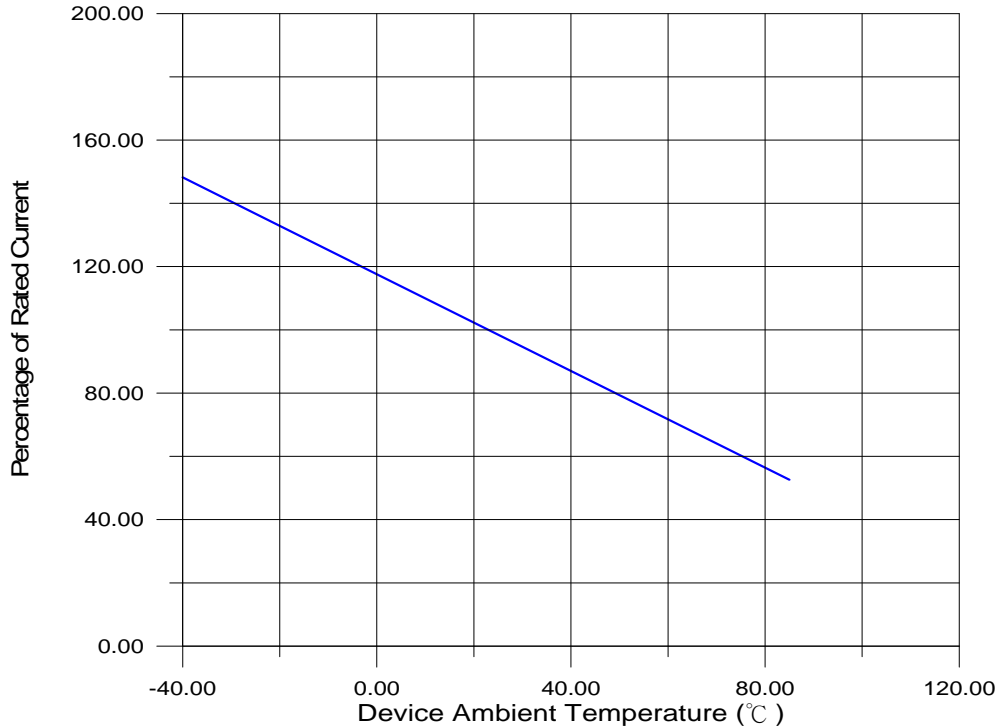

THERMAL DERATING CHART – I_{hold} (A)

Model	Ambient Temperature								
	-40°C	-20°C	0°C	23°C	40°C	50°C	60°C	70°C	85°C
RLD16P250GF	3.7	3.3	2.9	2.5	2.2	2.0	1.8	1.6	1.3
RLD16P300GF	4.4	4.0	3.5	3.0	2.6	2.4	2.1	1.9	1.6
RLD16P400GF	5.9	5.3	4.7	4.0	3.5	3.2	2.9	2.6	2.1
RLD16P500GF	7.4	6.6	5.9	5.0	4.4	4.0	3.6	3.2	2.6
RLD16P600GF	8.9	8.0	7.1	6.0	5.2	4.8	4.3	3.9	3.2
RLD16P700GF	10.4	9.3	8.2	7.0	6.1	5.6	5.0	4.5	3.7
RLD16P800GF	11.8	10.6	9.4	8.0	7.0	6.3	5.7	5.1	4.2
RLD16P900GF	13.3	12.0	10.6	9.0	7.8	7.1	6.5	5.8	4.7
RLD16P1000GF	14.8	13.3	11.8	10.0	8.7	7.9	7.1	6.4	5.3
RLD16P1100GF	16.3	14.6	12.9	11.0	9.6	8.7	7.9	7.0	5.8
RLD16P1200GF	17.7	15.9	14.1	12.0	10.5	9.5	8.6	7.7	6.3
RLD16P1400GF	20.7	18.6	16.5	14.0	12.2	11.1	10.0	9.0	7.4

07/17/2008

聚鼎科技股份有限公司 Polytronics Technology Corp.

 新竹市科學工業園區工業東四路 24 號之一 24-1, Industry E.4th Rd. Science Park, Hsinchu, Taiwan. TEL:886-3-5643931 FAX:886-3-5644624
 E-mail: pttc6368@ms22.hinet.net Http://www.pttc.com.tw

Radial Leaded PTC Devices

AVERAGE TIME-CURRENT CURVE FOR 16Vdc GF SERIES

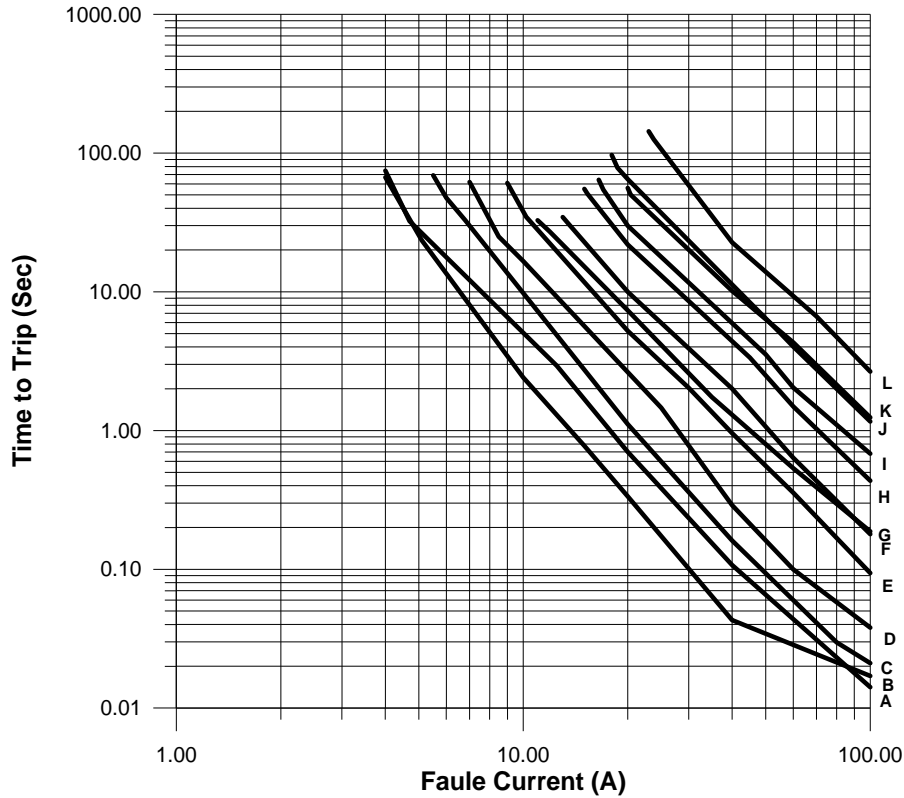

- A = RLD16P250GF
- B = RLD16P300GF
- C = RLD16P400GF
- D = RLD16P500GF
- E = RLD16P600GF
- F = RLD16P700GF
- G = RLD16P800GF
- H = RLD16P900GF
- I = RLD16P1000GF
- J = RLD16P1100GF
- K = RLD16P1200GF
- L = RLD16P1400GF

PART NUMBERING SYSTEM

RLD P F

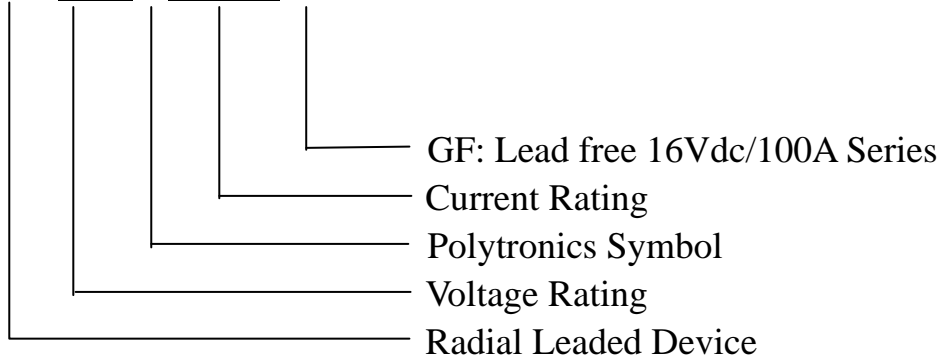

7/17/2008

聚鼎科技股份有限公司 Polytronics Technology Corp.

新竹市科學工業園區工業東四路 24 號之一 24-1, Industry E.4th Rd. Science Park, Hsinchu, Taiwan. TEL:886-3-5643931 FAX:886-3-5644624
E-mail: pttc6368@ms22.hinet.net Http://www.pttc.com.tw



Radial Leaded PTC Devices

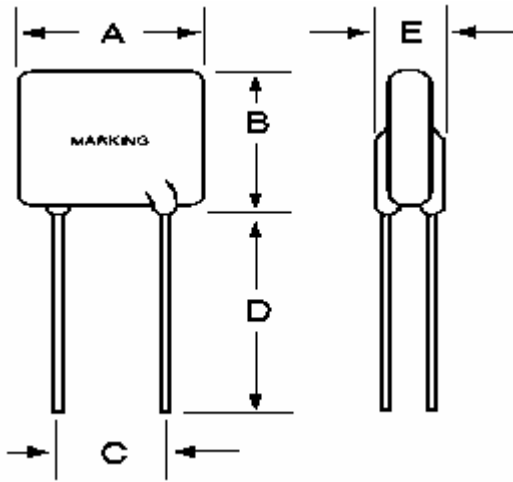

Figure 1

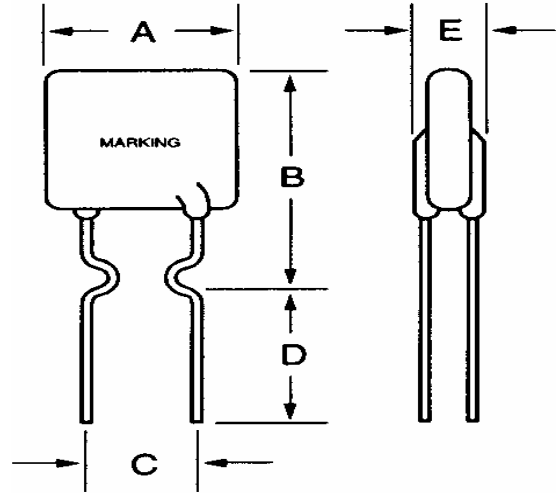

Figure 2

PHYSICAL DIMENSIONS (mm)

Part Number	Figure	A (max.)	B (max.)	C	D (min.)	E (max.)	Physical Characteristics	
							Lead	Material
RLD16P250GF	2	8.9	12.8	5.1±0.7	3.18	3.0	0.51 dia	Sn/CuFe
RLD16P300GF	1	7.1	11.0	5.1±0.8	7.6	3.0	0.81 dia	Sn/Cu
RLD16P400GF	1	8.9	12.8	5.1±0.8	7.6	3.0	0.81 dia	Sn/Cu
RLD16P500GF	1	10.4	14.3	5.1±0.8	7.6	3.0	0.81 dia	Sn/Cu
RLD16P600GF	1	10.7	17.1	5.1±0.8	7.6	3.0	0.81 dia	Sn/Cu
RLD16P700GF	1	11.2	19.7	5.1±0.8	7.6	3.0	0.81 dia	Sn/Cu
RLD16P800GF	1	12.7	20.9	5.1±0.8	7.6	3.0	0.81 dia	Sn/Cu
RLD16P900GF	1	14.0	21.7	5.1±0.8	7.6	3.0	0.81 dia	Sn/Cu
RLD16P1000GF	1	16.5	25.2	5.1±0.8	7.6	3.0	0.81 dia	Sn/Cu
RLD16P1100GF	1	17.5	26.0	5.1±0.8	7.6	3.0	0.81 dia	Sn/Cu
RLD16P1200GF	1	17.5	28.0	10.2±1.0	7.6	3.5	1.00 dia	Sn/Cu
RLD16P1400GF	1	23.5	27.9	10.2±1.0	7.6	3.5	1.00 dia	Sn/Cu

©Specifications are subject to change without notice.

07/17/2008

聚鼎科技股份有限公司 Polytronics Technology Corp.

新竹市科學工業園區工業東四路 24 號之一 24-1, Industry E.4th Rd. Science Park, Hsinchu, Taiwan. TEL:886-3-5643931 FAX:886-3-5644624
E-mail: pttc6368@ms22.hinet.net Http://www.pttc.com.tw



Radial Leaded PTC Devices

ENVIRONMENTAL SPECIFICATIONS

Operating/Storage Temperature	-40°C to +85°C	
Maximum Device Surface Temperature in Tripped State	125°C	
Passive Aging	+85°C, 1000 hours	±5% typical resistance change
Humidity Aging	+85°C, 85% R.H. 1000 hours	±5% typical resistance change
Thermal Shock	+85°C to -40°C 10 times	±5% typical resistance change
Solvent Resistance	MIL-STD-202, Method 215F	No change

PHYSICAL SPECIFICATIONS

Lead Material	P250GF: Tin-plated copper clad steel P300GF-P1400GF: Tin-plated copper
Soldering Characteristics	Solderability per MIL-STD-202, Method 208E
Insulating Material	Cured, flame retardant epoxy polymer meets UL94V-0 requirements.
Device Labeling	Marked with the letter "P", voltage, amperage rating, and lot number.

WAVE SOLDERING INFORMATIONS

Pre-Heating Zone	Refer to the condition recommended by the flux manufacturer. Max. ramping rate should not exceed 4°C/Sec.
Soldering Zone	Max. solder temperature should not exceed 260°C
Cooling Zone	Cooling by natural convection in air.

©Specifications are subject to change without notice.

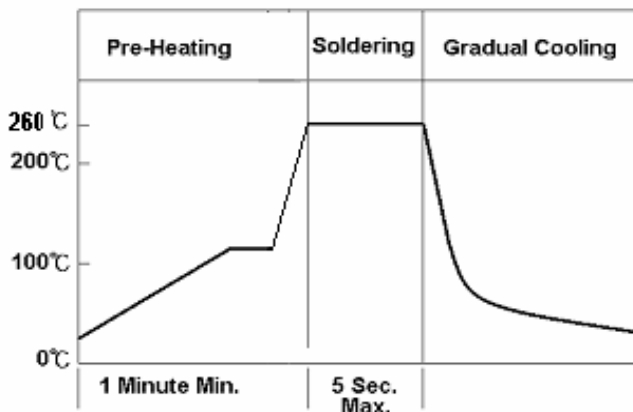

07/17/2008

聚鼎科技股份有限公司 Polytronics Technology Corp.

新竹市科學工業園區工業東四路 24 號之一 24-1, Industry E.4th Rd. Science Park, Hsinchu, Taiwan. TEL:886-3-5643931 FAX:886-3-5644624
E-mail: pttc6368@ms22.hinet.net Http://www.pttc.com.tw



Radial Leaded PTC Devices

TAPE AND REEL SPECIFICATIONS

Product availability: RLD16P250GF-RLD16P1400GF

Devices taped using EIA468-B/IE286-2 standards. See table below and Figures 1 and 2 for details.

Dimension Description	EIA Mark	IEC Mark	Dimensions	
			Dim.(mm)	Tol.(mm)
Carrier tape width	W	W	18	-0.5/+1.0
Hold down tape width:	W ₄	W ₀	11	min.
Top distance between tape edges	W ₆	W ₂	3	max.
Sprocket hole position	W ₅	W ₁	9	-0.5+0.75
Sprocket hole diameter*	D ₀	D ₀	4	-0.32/+0.2
Abscissa to plane(straight lead)	H	H	18.5	+3.0
Abscissa to plane(kinked lead)	H ₀	H ₀	16	+0.5
Abscissa to top			45.0	max.
Overall width w/o lead protrusion			56	max.
Overall width w/ lead protrusion			57	max.
Lead protrusion	L ₁	l ₁	1.0	max.
Protrusion of cut out	L	L	11	max.
Protrusion beyond hold-down tape	l ₂	l ₂	Not specified	
Sprocket hole pitch	P ₀	P ₀	25.4	+0.5
Device pitch:			25.4	
Pitch tolerance			20 consecutive.	+1
Tape thickness	t	t	0.9	max.
Tape thickness with splice	t ₁		2.0	max.
Splice sprocket hole alignment			0	+0.3
Body lateral deviation	Δh	Δh	0	+1.0
Body tape plane deviation	Δp	Δp	0	+1.3
Ordinate to adjacent component lead*	P ₁	P ₁	3.81	+0.7
Ordinate to adjacent component lead*			7.62	+0.7
Lead spacing:P250GF-P1100GF	F	F	5.08	+0.8
Lead spacing:P1200GF-P1400GF	F	F	10.18	+0.8
Reel width	w ₂	w	63.5	max.
Reel diameter	a	d	370	max.
Space between flanges less device*	w ₁		4.75	3.25/+8.25
Arbor hole diameter	c	f	26	+12.0
Core diameter*	n	h	91	max.
Box			64/372/372	max.
Consecutive missing places			None	
Empty places per reel			0.1% max.	

*Differs from EIA specification

07/17/2008

聚鼎科技股份有限公司 Polytronics Technology Corp.

新竹市科學工業園區工業東四路 24 號之一 24-1, Industry E.4th Rd. Science Park, Hsinchu, Taiwan. TEL:886-3-5643931 FAX:886-3-5644624
E-mail: pttc6368@ms22.hinet.net Http://www.pttc.com.tw



Radial Leaded PTC Devices

TAPE AND REEL SPECIFICATIONS

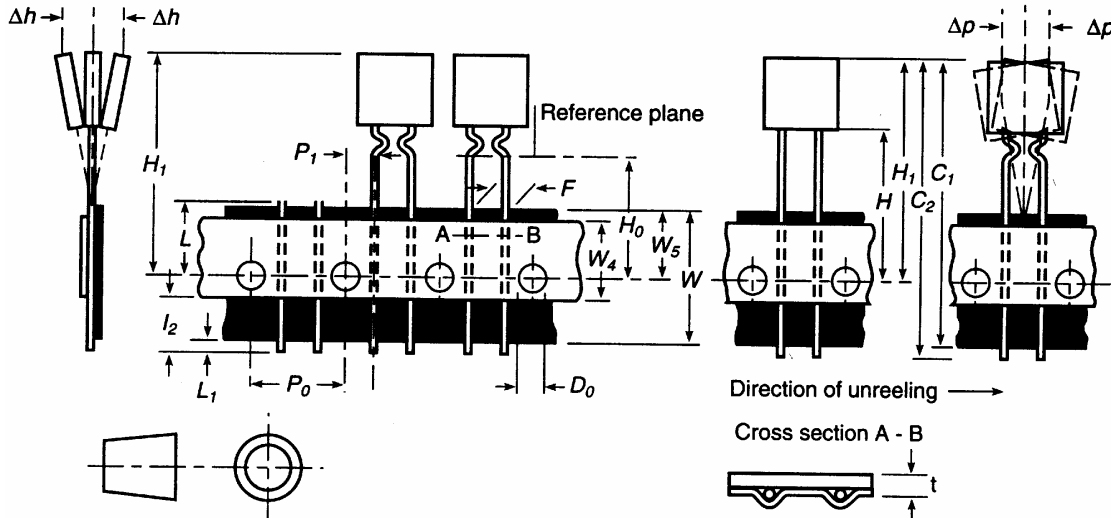

Figure 1

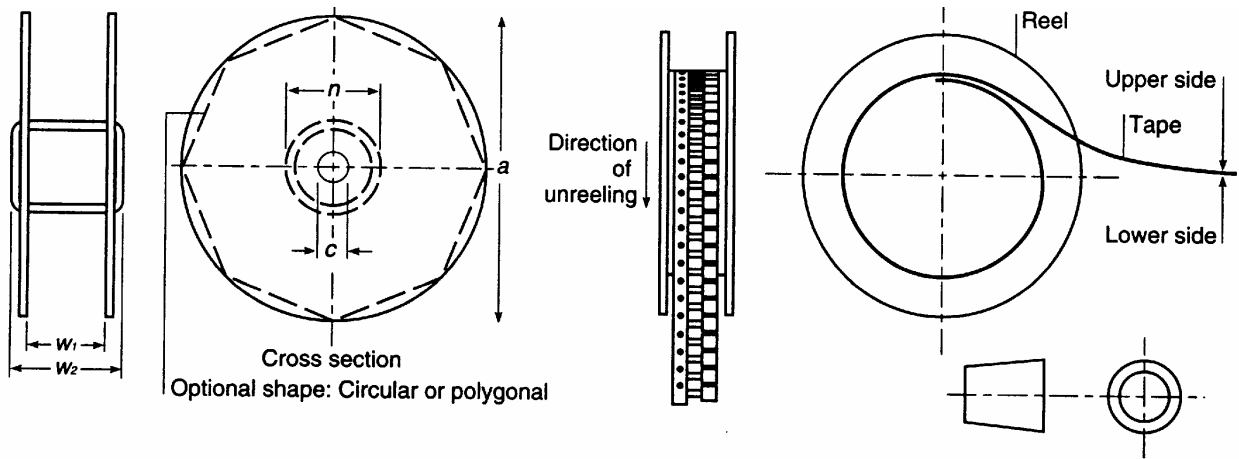

Figure 2

07/17/2008

聚鼎科技股份有限公司 Polytronics Technology Corp.

新竹市科學工業園區工業東四路 24 號之一 24-1, Industry E.4th Rd. Science Park, Hsinchu, Taiwan. TEL:886-3-5643931 FAX:886-3-5644624
E-mail: pttc6368@ms22.hinet.net Http://www.pttc.com.tw



Radial Leaded PTC Devices

PACKAGING INFORMATION

Product Description	Part I.D.	Bag Quantity	Reelpack Quantity	Ammopack Quantity
RLD16P250GF	250G	500	2500	2000
RLD16P300GF	300G	500	2500	2000
RLD16P400GF	400G	500	2500	2000
RLD16P500GF	500G	500	2000	2000
RLD16P600GF	600G	500	2000	2000
RLD16P700GF	700G	200	1500	1500
RLD16P800GF	800G	200	1000	1000
RLD16P900GF	900G	200	1000	1000
RLD16P1000GF	1000G	200	1000	1000
RLD16P1100GF	1100G	200	1000	1000
RLD16P1200GF	1200G	100	1000	1000
RLD16P1400GF	1400G	100	1000	1000

PART MARKING SYSTEM

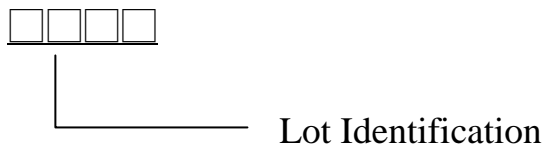
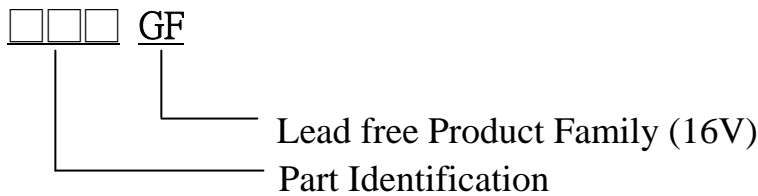
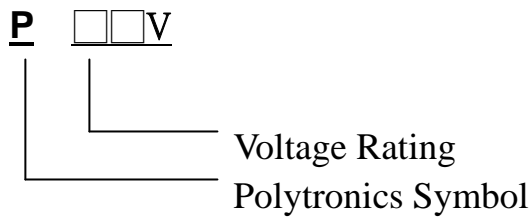

07/17/2008

聚鼎科技股份有限公司 Polytronics Technology Corp.

 新竹市科學工業園區工業東四路 24 號之一 24-1, Industry E.4th Rd. Science Park, Hsinchu, Taiwan. TEL:886-3-5643931 FAX:886-3-5644624
 E-mail: pttc6368@ms22.hinet.net Http://www.pttc.com.tw

Radial Leaded PTC Devices**CROSS REFERENCE**

Polytronics/ EVERFUSE™	Cross Reference
	Raychem/ PolySwitch®
RLD16P250GF	RGEF250
RLD16P300GF	RGEF300
RLD16P400GF	RGEF400
RLD16P500GF	RGEF500
RLD16P600GF	RGEF600
RLD16P700GF	RGEF700
RLD16P800GF	RGEF800
RLD16P900GF	RGEF900
RLD16P1000GF	RGEF1000
RLD16P1100GF	RGEF1100
RLD16P1200GF	RGEF1200
RLD16P1400GF	RGEF1400

“EVERFUSE” is a registered trademark of Polytronics Technology Corp.

“PolySwitch” is a registered trademark of Raychem Corporation.

© Specifications are subject to change without notice.

07/17/2008

聚鼎科技股份有限公司 Polytronics Technology Corp.

新竹市科學工業園區工業東四路 24 號之一 24-1, Industry E.4th Rd. Science Park, Hsinchu, Taiwan. TEL:886-3-5643931 FAX:886-3-5644624
E-mail: pttc6368@ms22.hinet.net Http://www.pttc.com.tw

