

APT07D5B – ESD Protection Diode

Feature

- 350 Watts peak pulse power (8/20 μ s)
- Bidirectional configurations
- Solid state silicon-avalanche technology
- Low clamping voltage
- Low leakage current
- IEC61000-4-2 (ESD) \pm 25kV (Air), \pm 25kV (Contact)
- IEC61000-4-4 (EFT) 40A (5/50ns)
- IEC61000-4-5 (Lightning): 15A (8/20 μ s)
- AEC-Q101 qualified

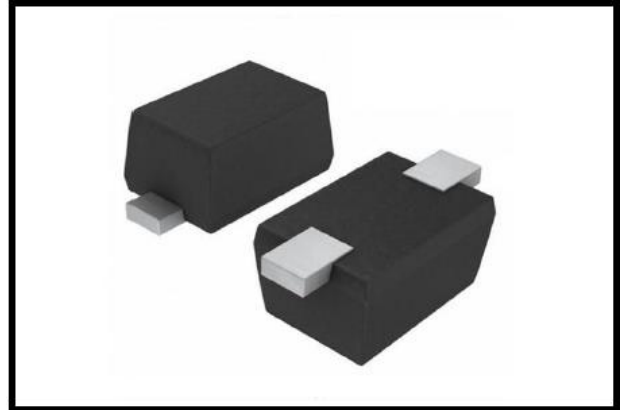

Applications

- Microprocessor based equipment
- Notebooks, Desktops, and Servers
- Portable Instrumentation
- Personal Digital Assistant (PDA)
- Cell Phone Handsets and Accessories

Mechanical Data

- SOD523 package
- Molding compound flammability rating: UL94 V-0
- Tape and Reel Packaging
- RoHS/WEEE Compliant

Schematic and PIN Configuration

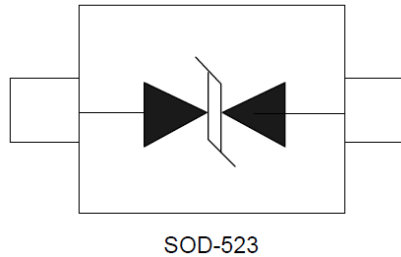

Maximum Rating

Parameter	Symbol	Limit	Unit
IEC61000-4-2 ESD Voltage – Air Mode	$V_{ESD}^{(1)}$	\pm 25	kV
IEC61000-4-2 ESD Voltage – Contact Mode		\pm 25	
Peak Pulse Power	$P_{PP}^{(2)}$	350	W
Peak Pulse Current	$I_{PP}^{(2)}$	15	A
Maximum Lead Solder Temperature (10 seconds duration)	T_L	260	$^{\circ}$ C
Junction Temperature	T_J	-55~150	$^{\circ}$ C
Storage Temperature Range	T_{stg}	-55~150	$^{\circ}$ C

Note:

1. Device stressed with ten non-repetitive ESD pulses.
2. Non-repetitive current pulse 8/20 μ s exponential decay waveform according to IEC61000-4-5.
3. All ratings are measured at environmental temperature of TA = 25 $^{\circ}$ C unless otherwise noted.

APT07D5B – ESD Protection Diode

Electrical Characteristics

Parameter	Symbol	Test Conditions	Min	Typ	Max	Unit
Reverse Stand-off Voltage	$V_{RWM}^{(1)}$				7.0	V
Reverse Breakdown Voltage	V_{BR}	$I_T = 1mA$	8.0			V
Reverse Leakage Current	I_R	$V_{RWM} = 7V$			1.0	μA
Clamping Voltage	$V_C^{(2)}$	$I_{PP} = 15A$			25	V
Junction Capacitance	C_J	$V_R = 0V, f = 1MHz$			60	pF

Note:

1. Other voltages available upon request.
2. Non-repetitive current pulse 8/20 μs exponential decay waveform according to IEC61000-4-5.
3. All ratings are measured at environmental temperature of $T_A = 25^\circ C$ unless otherwise noted.

Electrical Parameters

Symbol	Parameter
V_C	Clamping Voltage @ I_{PP}
I_{PP}	Reverse Peak Pulse Current
V_{BR}	Breakdown Voltage @ I_T
I_T	Test Current
I_R	Reverse Leakage Current @ V_{RWM}
V_{RWM}	Working Peak Reverse Voltage

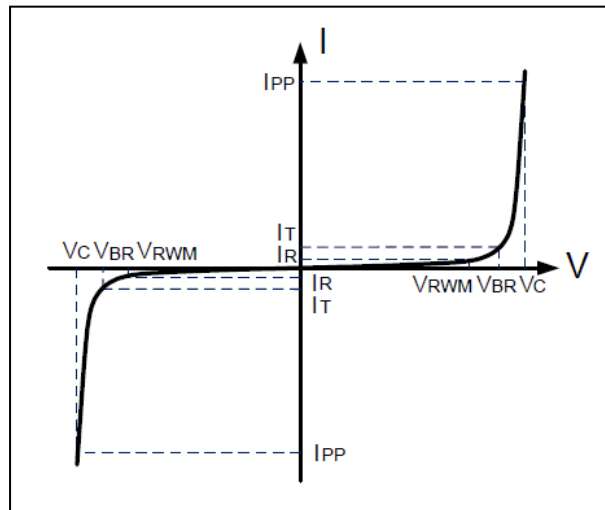

APT07D5B – ESD Protection Diode

Typical Characteristics

Figure 1: Peak Pulse Power vs. Pulse Time

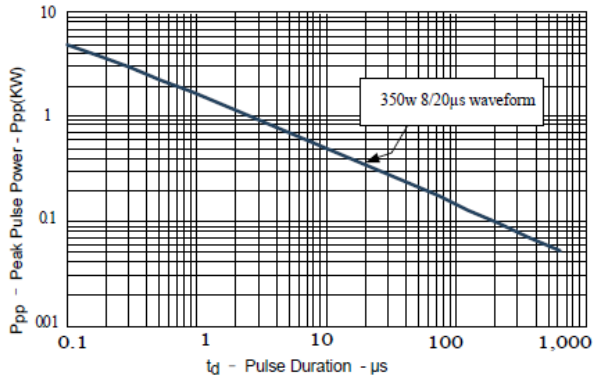

Figure 2: Power Derating Curve

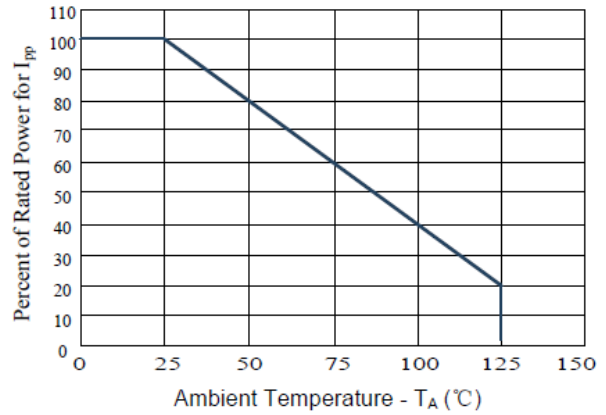

Figure 3: Pulse Waveform

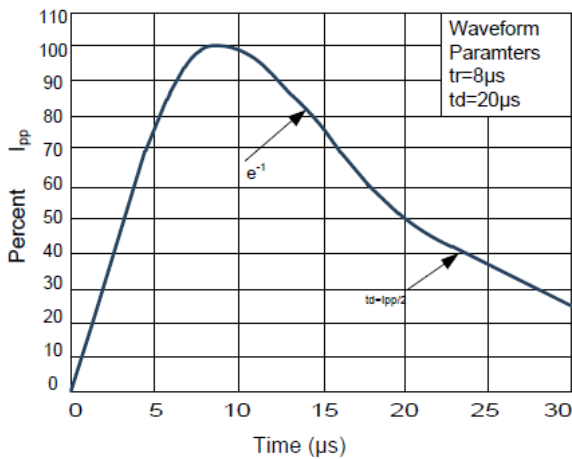
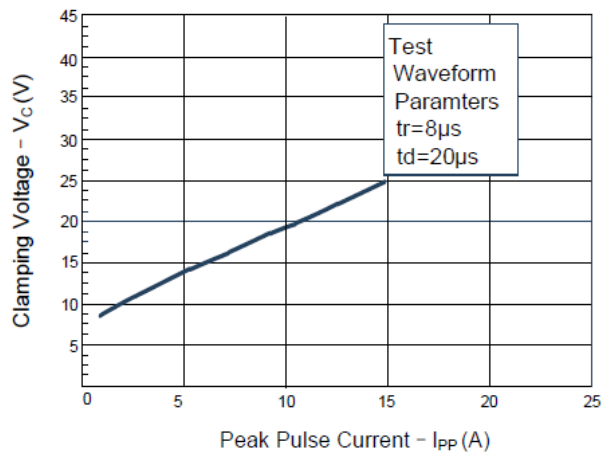
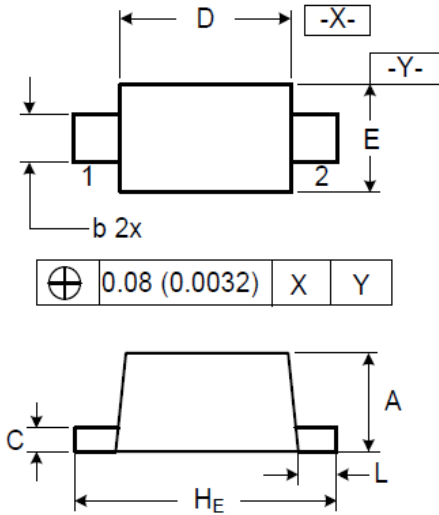

Figure 4: Clamping Voltage vs. Ipp



APT07D5B – ESD Protection Diode

SOD523 Package Outline Dimensions



Symbol	Dimensions (mm)	
	Min	Max
A	0.500	0.700
b	0.250	0.350
C	0.070	0.200
D	1.100	1.300
E	0.700	0.900
H _E	1.500	1.700
L	0.150	0.250

Marking

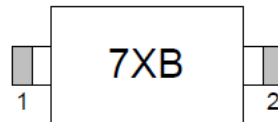

Packaging Information

Order Code	Packaging	Reel Size	PCS/Reel
APT07D5B	SOD523	7 inch	5,000