

## PCLC08D3CE – ESD Protection Diode

### Feature

- 180 Watts peak pulse power (8/20  $\mu$ s)
- Bidirectional configurations
- Low clamping voltage
- Low leakage current
- Protect one data line
- Low Capacitance: 1.7 pF Typical
- Response Time is Typically < 1 ns
- Solid-state Silicon-avalanche Technology
- IEC61000-4-2 (ESD)  $\pm$ 30 kV (Air),  $\pm$ 30 kV (Contact)
- IEC61000-4-4 (EFT) 40 A (5/50ns)
- IEC61000-4-5 (Lightning): 20 A (8/20 $\mu$ s)

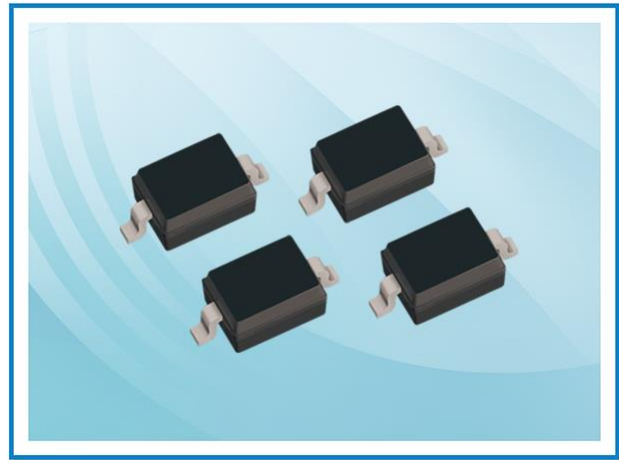

### Applications

- Microprocessor based equipment
- Notebook, Desktops, and Server
- Personal Digital Assistant (PDA)
- Portable Instrumentation
- Networking

### Mechanical Data

- SOD323 package
- Molding compound flammability rating: UL94 V-0
- Tape and Reel Packaging
- RoHS/WEEE Compliant

### Schematic and PIN Configuration

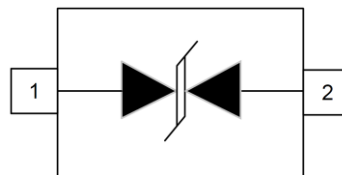

SOD-323

### Maximum Rating

Parameter	Symbol	Limit	Unit
IEC61000-4-2 ESD Voltage – Air Mode	$V_{ESD}^{(1)}$	$\pm$ 30	kV
IEC61000-4-2 ESD Voltage – Contact Mode		$\pm$ 30	
Peak Pulse Power	$P_{PP}^{(2)}$	180	W
Peak Pulse Current	$I_{PP}^{(2)}$	20	A
Maximum Lead Solder Temperature (10 seconds duration)	$T_L$	260	$^{\circ}$ C
Junction Temperature	$T_J$	-55~125	$^{\circ}$ C
Storage Temperature Range	$T_{stg}$	-55~125	$^{\circ}$ C

Note:

1. Device stressed with ten non-repetitive ESD pulses.
2. Non-repetitive current pulse 8/20 $\mu$ s exponential decay waveform according to IEC61000-4-5.
3. All ratings are measured at environmental temperature of TA = 25  $^{\circ}$ C unless otherwise noted.

## PCLC08D3CE – ESD Protection Diode

### Electrical Characteristics

Parameter	Symbol	Test Conditions	Min	Typ	Max	Unit
Reverse Stand-off Voltage	$V_{RWM}^{(1)}$				8.0	V
Reverse Breakdown Voltage	$V_{BR}$	$I_T = 1 \text{ mA}$	10.0			V
Reverse Leakage Current	$I_R$	$V_{RWM} = 8 \text{ V}$			0.5	$\mu\text{A}$
Holding Voltage	$V_H$	$I_H = 60 \text{ mA}$	2.0			V
Clamping Voltage	$V_C^{(2)}$	$I_{PP} = 20 \text{ A}$			9.0	V
Junction Capacitance	$C_J$	$V_R = 0 \text{ V}, f = 1 \text{ MHz}$		1.7	2.0	pF

Note:

1. Other voltages available upon request.
2. Non-repetitive current pulse 8/20 $\mu\text{s}$  exponential decay waveform according to IEC61000-4-5.
3. All ratings are measured at environmental temperature of  $T_A = 25^\circ\text{C}$  unless otherwise noted.

### Electrical Parameters

Symbol	Parameter
$V_C$	Clamping Voltage @ $I_{PP}$
$I_{PP}$	Reverse Peak Pulse Current
$V_{BR}$	Breakdown Voltage @ $I_T$
$V_Y$	Trigger Voltage
$V_H$	Holding Voltage
$I_H$	Holding Current
$I_T$	Test Current
$I_R$	Reverse Leakage Current @ $V_{RWM}$
$V_{RWM}$	Working Peak Reverse Voltage

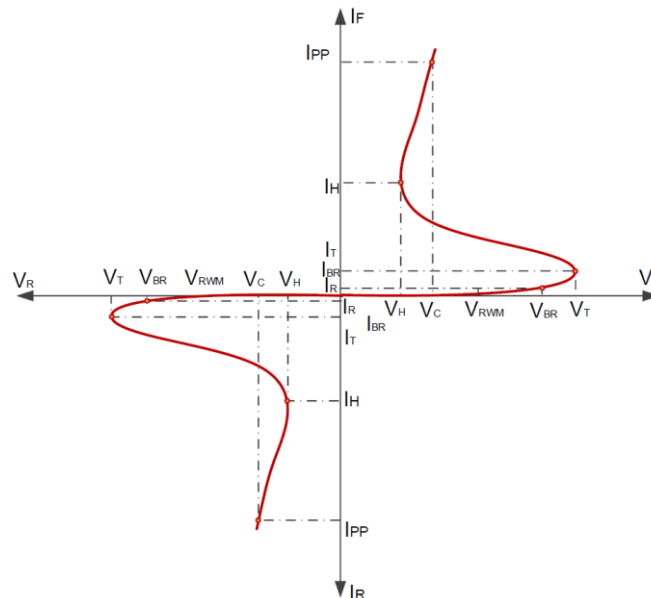

## PCLC08D3CE – ESD Protection Diode

### Typical Characteristics

Figure 1: Peak Pulse Power vs. Pulse Time

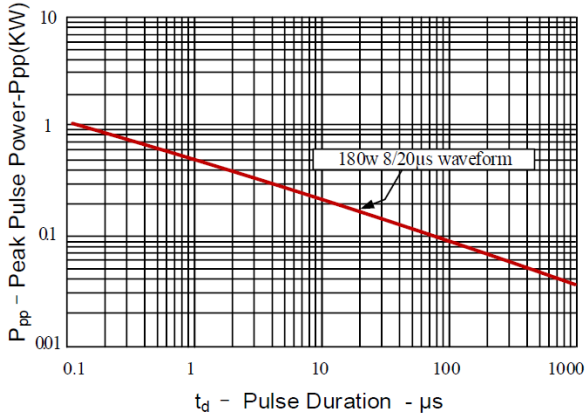

Figure 2: Power Derating Curve

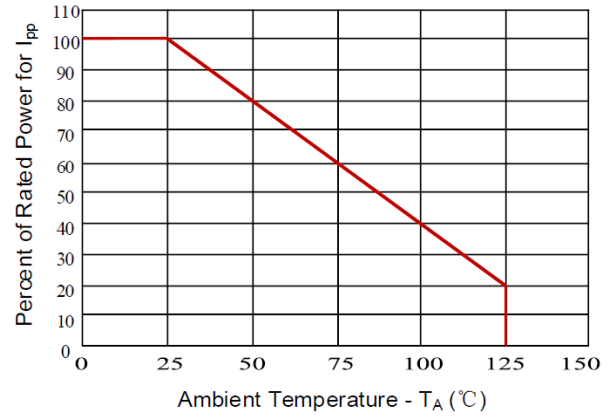

Figure 3: Pulse Waveform

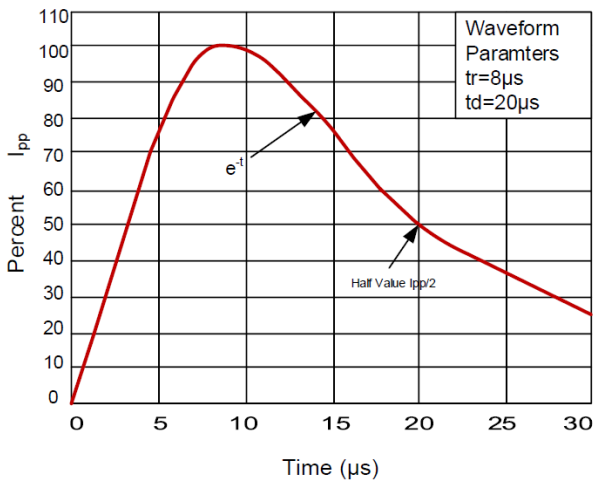
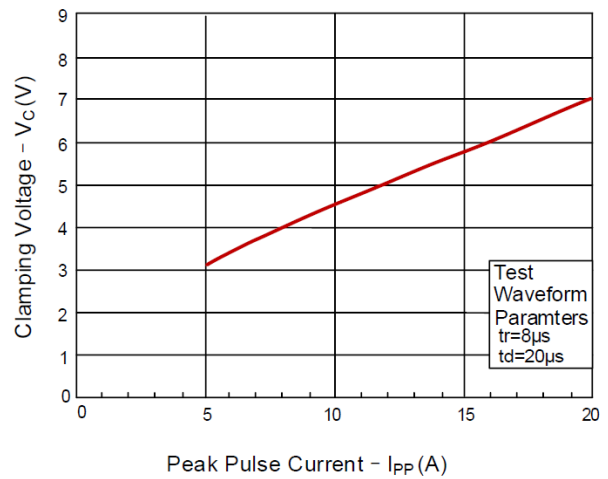
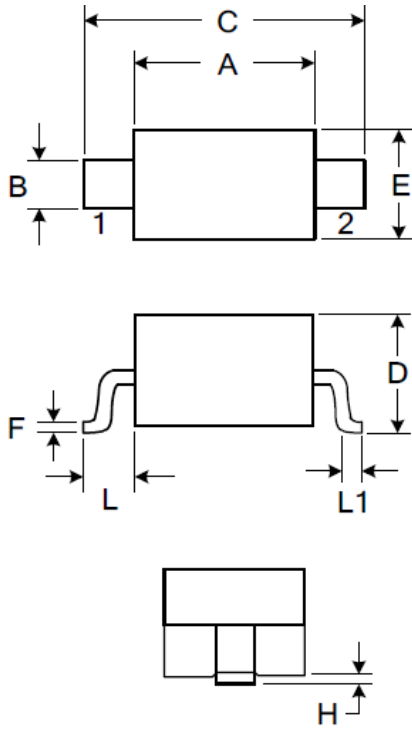

Figure 4: Clamping Voltage vs. I\_pp



## PCLC08D3CE – ESD Protection Diode

### SOD323 Package Outline Dimensions



Symbol	Dimensions (mm)		Dimensions (inch)	
	Min	Max	Min	Max
A	1.600	1.800	0.063	0.071
B	0.250	0.350	0.010	0.014
C	2.500	2.700	0.098	0.106
D		1.000		0.039
E	1.200	1.400	0.047	0.055
F	0.080	0.150	0.003	0.006
L	0.475 Ref.		0.019 Ref.	
L1	0.250	0.400	0.010	0.016
H		0.100		0.004

### Land Pattern

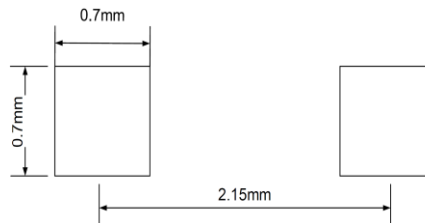

\* This Land Pattern is For Reference Purposes Only

### Marking



### Packaging Information

Order Code	Packaging	Reel Size	PCS/Reel
PCLC08D3CE	SOD323	7 inch	3,000