

PT12D3CE – ESD Protection Diode

Feature

- 330 Watts peak pulse power (8/20 μ s)
- Bidirectional configurations
- Solid state silicon-avalanche technology
- Low clamping voltage
- Low leakage current
- IEC61000-4-2 (ESD) \pm 30kV (Air), \pm 30kV (Contact)
- IEC61000-4-4 (EFT) 40A (5/50ns)
- IEC61000-4-5 (Lightning): 15A (8/20 μ s)

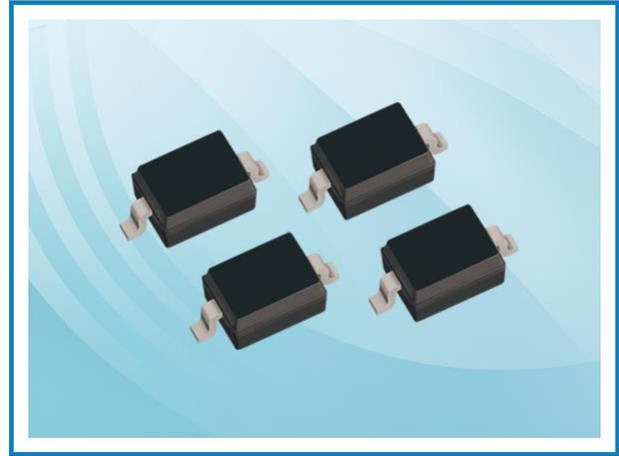

Applications

- Microprocessor based equipment
- Notebooks, Desktops, and Servers
- Portable Instrumentation
- Personal Digital Assistant (PDA)
- Pagers Peripherals

Mechanical Data

- SOD323 package
- Molding compound flammability rating: UL94 V-0
- Tape and Reel Packaging
- RoHS/WEEE Compliant

Schematic and PIN Configuration

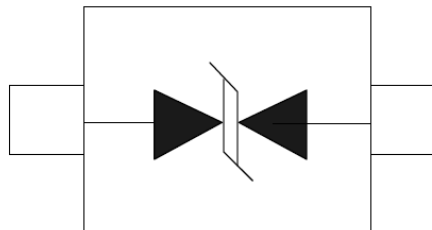

SOD-323

Maximum Rating

Parameter	Symbol	Limit	Unit
IEC61000-4-2 ESD Voltage – Air Mode	$V_{ESD}^{(1)}$	\pm 30	kV
IEC61000-4-2 ESD Voltage – Contact Mode		\pm 30	
Peak Pulse Power	$P_{PP}^{(2)}$	330	W
Peak Pulse Current	$I_{PP}^{(2)}$	15	A
Maximum Lead Solder Temperature (10 seconds duration)	T_L	260	$^{\circ}$ C
Junction Temperature	T_J	-55~150	$^{\circ}$ C
Storage Temperature Range	T_{stg}	-55~150	$^{\circ}$ C

Note:

1. Device stressed with ten non-repetitive ESD pulses.
2. Non-repetitive current pulse 8/20 μ s exponential decay waveform according to IEC61000-4-5.
3. All ratings are measured at environmental temperature of $T_A = 25^{\circ}$ C unless otherwise noted.

PT12D3CE – ESD Protection Diode

Electrical Characteristics

Parameter	Symbol	Test Conditions	Min	Typ	Max	Unit
Reverse Stand-off Voltage	$V_{RWM}^{(1)}$				12	V
Reverse Breakdown Voltage	V_{BR}	$I_T = 1\text{mA}$	13.3			V
Reverse Leakage Current	I_R	$V_{RWM} = 12\text{V}$			1.0	μA
Clamping Voltage	$V_C^{(2)}$	$I_{PP} = 15\text{A}$		22	28	V
Junction Capacitance	C_J	$V_R = 0\text{V}, f = 1\text{MHz}$		35	45	pF

Note:

1. Other voltages available upon request.
2. Non-repetitive current pulse 8/20 μs exponential decay waveform according to IEC61000-4-5.
3. All ratings are measured at environmental temperature of $T_A = 25^\circ\text{C}$ unless otherwise noted.

Electrical Parameters

Symbol	Parameter
V_C	Clamping Voltage @ I_{PP}
I_{PP}	Reverse Peak Pulse Current
V_{BR}	Breakdown Voltage @ I_T
I_T	Test Current
I_R	Reverse Leakage Current @ V_{RWM}
V_{RWM}	Working Peak Reverse Voltage

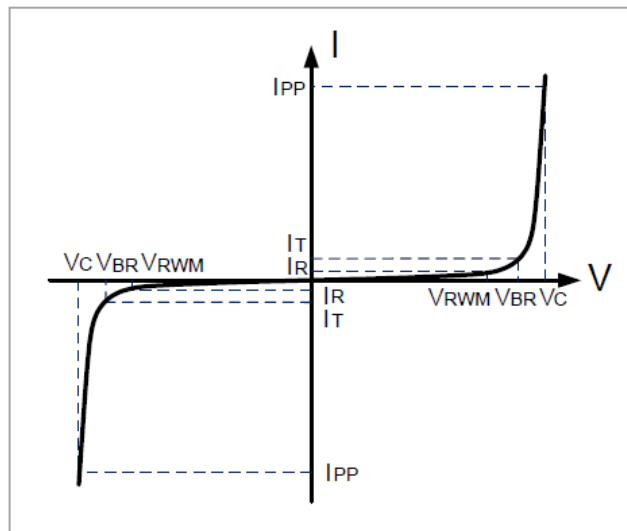

PT12D3CE – ESD Protection Diode

Typical Characteristics

Figure 1: Peak Pulse Power vs. Pulse Time

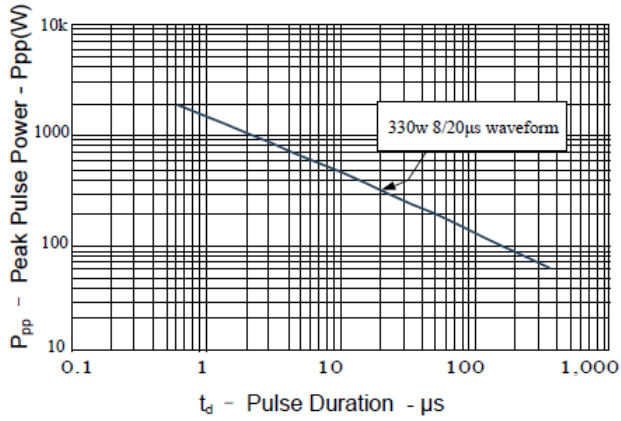

Figure 2: Power Derating Curve

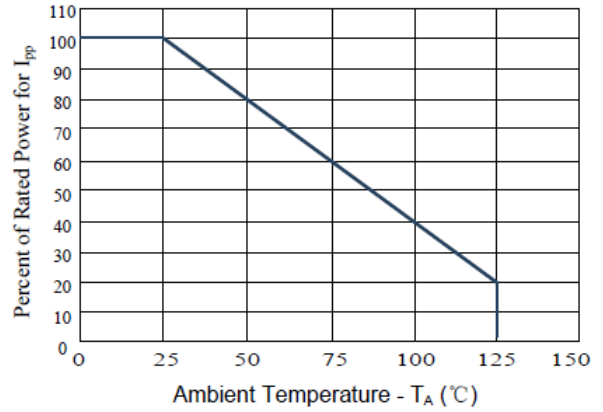

Figure 3: Pulse Waveform

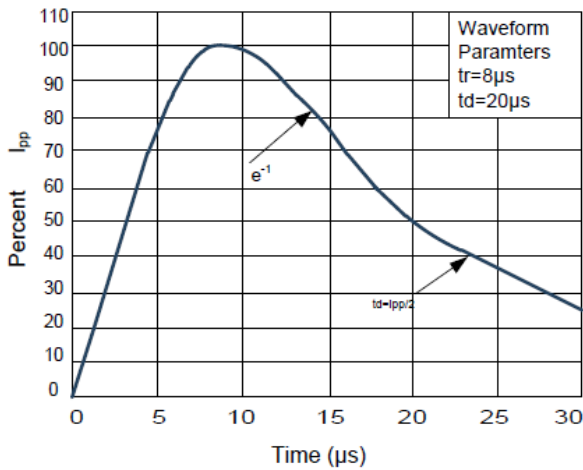
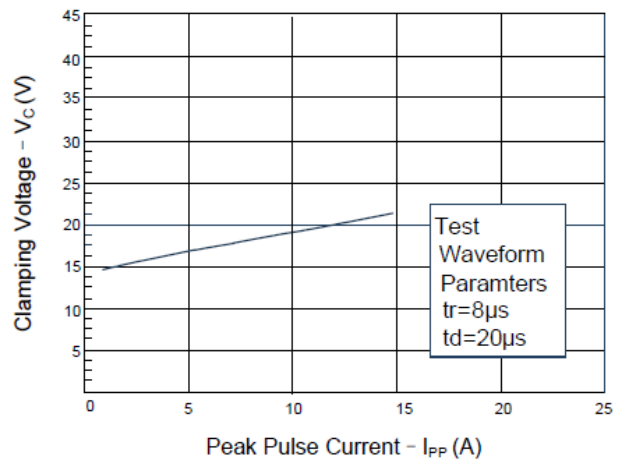
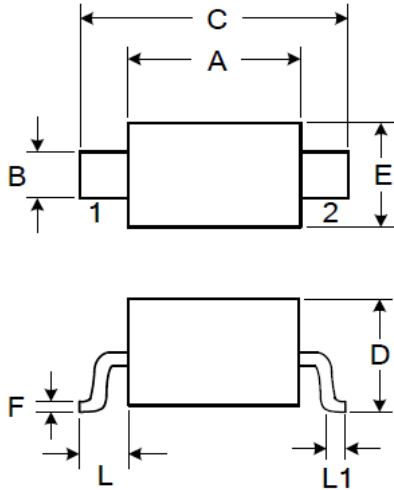

Figure 4: Clamping Voltage vs. Ipp



PT12D3CE – ESD Protection Diode

SOD323 Package Outline Dimensions



Symbol	Dimensions (mm)	
	Min	Max
A	1.600	1.800
B	0.250	0.350
C	2.500	2.700
D		1.000
E	1.200	1.400
F	0.080	0.150
L	0.475 Ref.	
L1	0.250	0.400
H		0.100

Marking



Packaging Information

Order Code	Packaging	Reel Size	PCS/Reel
PT12D3CE	SOD323	7 inch	3,000