

## PT36D3CE – ESD Protection Diode

### Feature

- 500 Watts peak pulse power (8/20 $\mu$ s)
- Bidirectional configurations
- Solid state silicon-avalanche technology
- Low clamping voltage
- Low leakage current
- IEC61000-4-2 (ESD)  $\pm$ 20kV (Air),  $\pm$ 15kV (Contact)
- IEC61000-4-4 (EFT) 40A (5/50ns)
- IEC61000-4-5 (Lightning): 5A (8/20 $\mu$ s)

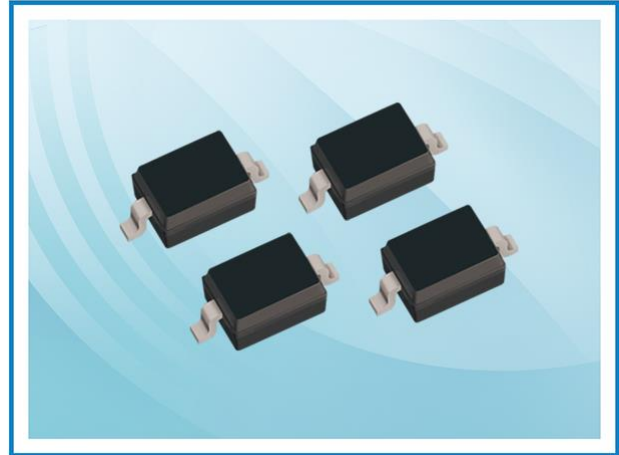

### Applications

- Microprocessor based equipment
- Notebooks, Desktops, and Servers
- Portable Instrumentation
- Personal Digital Assistant (PDA)
- Pagers Peripherals

### Mechanical Data

- SOD323 package
- Molding compound flammability rating: UL94 V-0
- Tape and Reel Packaging
- RoHS/WEEE Compliant
- Moisture Sensitivity Level : Level 1

### Schematic and PIN Configuration

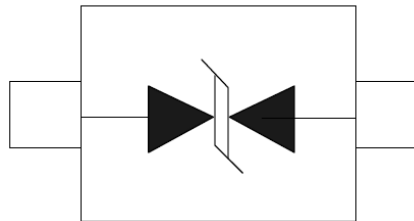

SOD-323

### Maximum Rating

Parameter	Symbol	Limit	Unit
IEC61000-4-2 ESD Voltage – Air Mode	$V_{ESD}^{(1)}$	$\pm$ 20	kV
IEC61000-4-2 ESD Voltage – Contact Mode		$\pm$ 15	
Peak Pulse Power	$P_{PP}^{(2)}$	500	W
Peak Pulse Current	$I_{PP}^{(2)}$	5	A
Maximum Lead Solder Temperature (10 seconds duration)	$T_L$	260	$^{\circ}$ C
Junction Temperature	$T_J$	-55~150	$^{\circ}$ C
Storage Temperature Range	$T_{stg}$	-55~150	$^{\circ}$ C

Note:

1. Device stressed with ten non-repetitive ESD pulses.
2. Non-repetitive current pulse 8/20 $\mu$ s exponential decay waveform according to IEC61000-4-5.
3. All ratings are measured at environmental temperature of TA = 25  $^{\circ}$ C unless otherwise noted.

## PT36D3CE – ESD Protection Diode

### Electrical Characteristics

Parameter	Symbol	Test Conditions	Min	Typ	Max	Unit
Reverse Stand-off Voltage	$V_{RWM}^{(1)}$				36	V
Reverse Breakdown Voltage	$V_{BR}$	$I_T = 1\text{mA}$	40			V
Reverse Leakage Current	$I_R$	$V_{RWM} = 36\text{V}$			0.5	$\mu\text{A}$
Clamping Voltage	$V_C^{(2)}$	$I_{PP} = 5\text{A}$		100	130	V
Junction Capacitance	$C_J$	$V_R = 0\text{V}, f = 1\text{MHz}$		13	17	pF

Note:

1. Other voltages available upon request.
2. Non-repetitive current pulse 8/20 $\mu\text{s}$  exponential decay waveform according to IEC61000-4-5.
3. All ratings are measured at environmental temperature of  $T_A = 25^\circ\text{C}$  unless otherwise noted.

### Electrical Parameters

Symbol	Parameter
$V_C$	Clamping Voltage @ $I_{PP}$
$I_{PP}$	Reverse Peak Pulse Current
$V_{BR}$	Breakdown Voltage @ $I_T$
$I_T$	Test Current
$I_R$	Reverse Leakage Current @ $V_{RWM}$
$V_{RWM}$	Working Peak Reverse Voltage

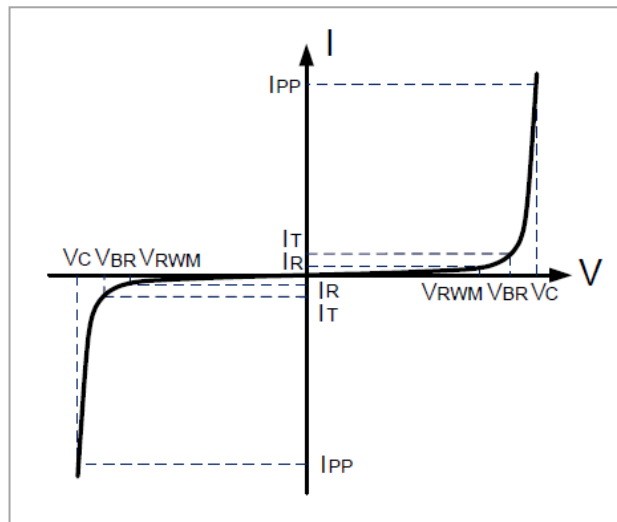

## PT36D3CE – ESD Protection Diode

### Typical Characteristics

Figure 1: Peak Pulse Power vs. Pulse Time

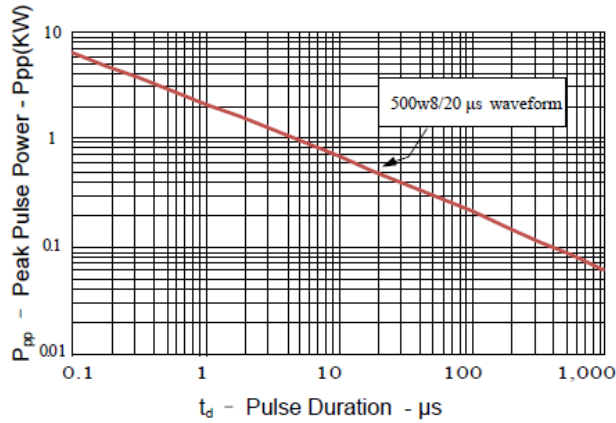

Figure 2: Power Derating Curve

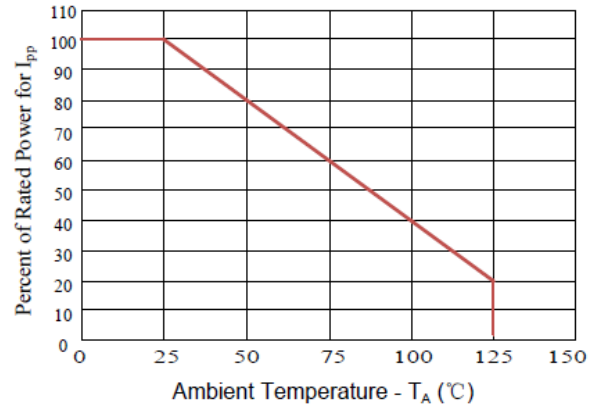

Figure3: Pulse Waveform

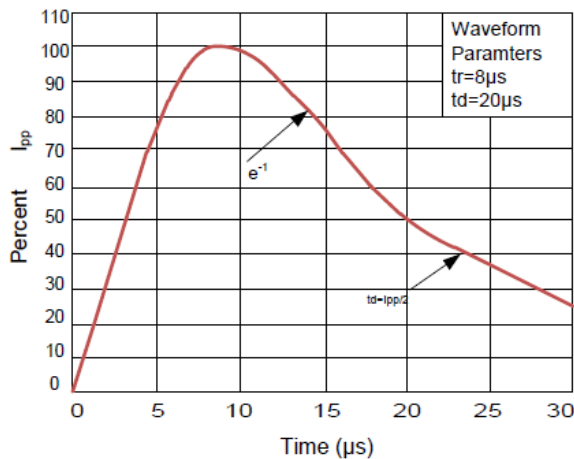
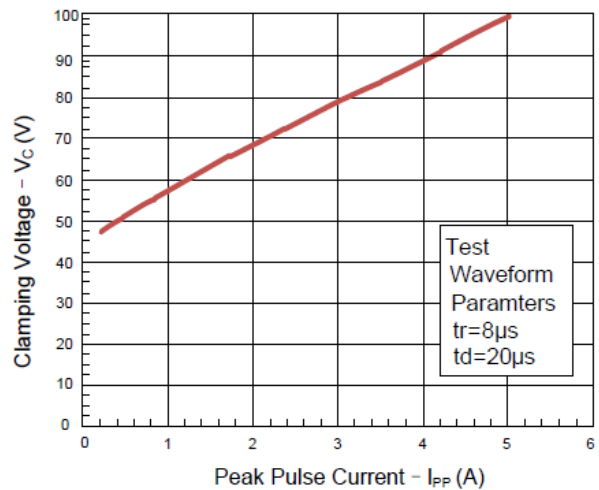
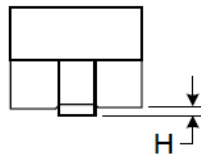
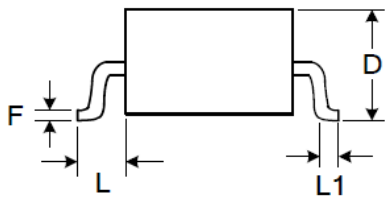
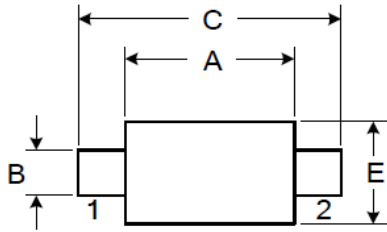

Figure 4: Clamping Voltage vs. Ipp



## PT36D3CE – ESD Protection Diode

### SOD323 Package Outline Dimensions



Symbol	Dimensions (mm)	
	Min	Max
A	1.600	1.800
B	0.250	0.350
C	2.500	2.700
D		1.000
E	1.200	1.400
F	0.080	0.150
L	0.475 Ref.	
L1	0.250	0.400
H		0.100

### Marking



## PT36D3CE – ESD Protection Diode

### Soldering Parameters

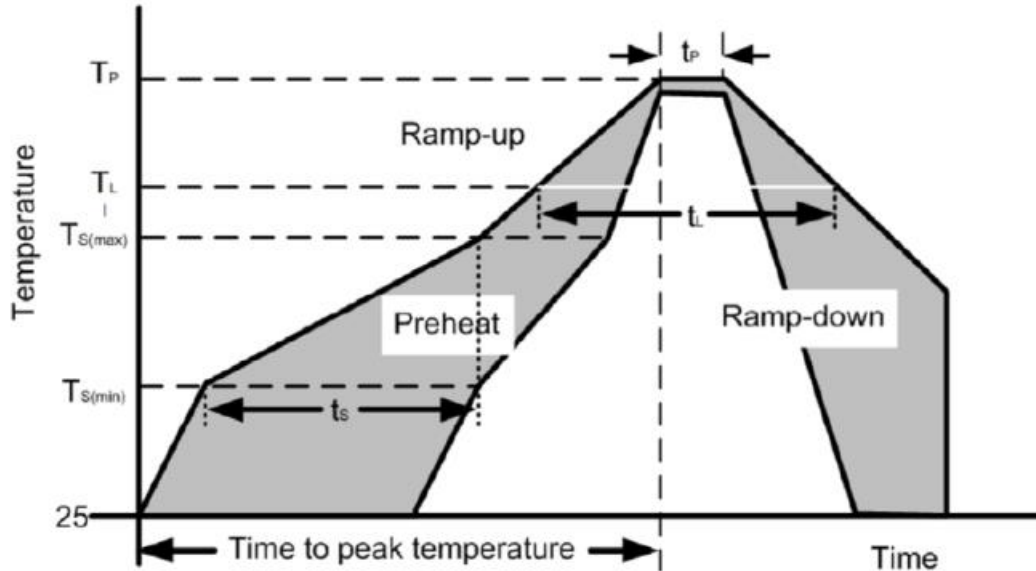

Reflow Condition	Pb-Free assembly
Pre Heat Temperature Min (Ts (min) ) 150°C	Temperature Min (Ts (min) ) 150°C
Pre Heat Temperature Min (Ts (max) ) 200°C	Temperature Min (Ts (max) ) 200°C
Pre Heat Time (min to max) (ts) 60-190 secs	Time (min to max) (ts) 60-190 secs
Average ramp up rate (Liquidus Temp) (TL) to peak	5°C/seconds max
Ts(max)to TL—Ramp-up Rate	5°C/seconds max
Reflow Temperature (TL) (Liquidus)	217°C
Reflow Temperature (tl)	60-150 seconds
Peak Temperature (Tp)	260+0/-5°C
Time within actual peak Temperature (tp)	20-40 seconds
Ramp-down Rate	5°C/seconds max
Time 25°C to peak Temperature (Tp)	8 minutes Max.
Do not exceed	280°C

## PT36D3CE – ESD Protection Diode

### Packaging Information

Order Code	Packaging	Reel Size	PCS/Reel
PT36D3CE	SOD323	7 inch	3,000

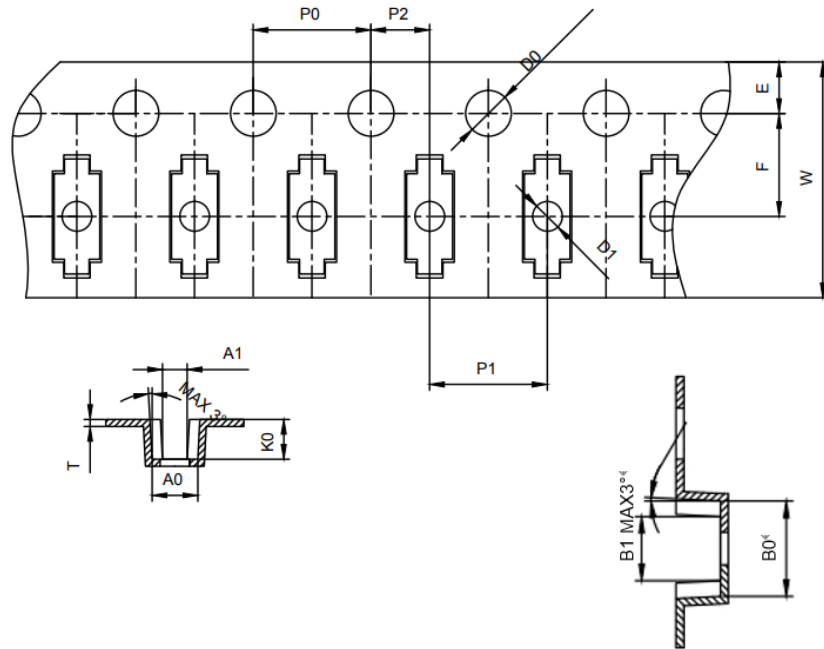

Carrier Tape	SOD323 (mm)	Tolerance
A0	1.50	±0.1
A1	0.84	±0.1
B0	2.80	±0.1
K0	1.20	±0.1
P0	4.00	±0.1
P1	4.00	±0.05
P2	2.00	±0.05
T	0.23	±0.03
E	1.75	±0.1
F	3.50	±0.05
D0	1.55	±0.5
D1	1.10	±0.1
W	8.00	+0.3/-0.1
B1	1.95	±0.1

## PT36D3CE – ESD Protection Diode

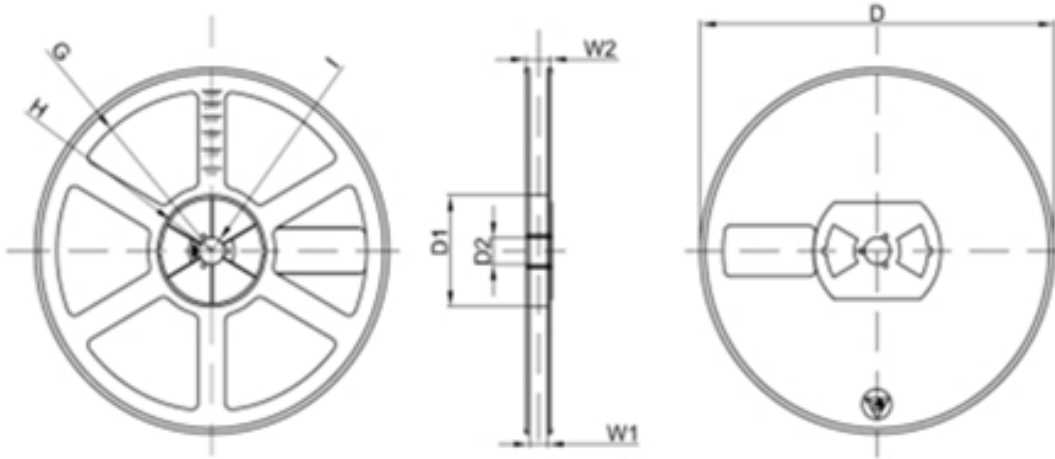

Reel Option	7" dia (mm)	Tolerance
D	Ø178.00	±2
D1	54.40	±1
D2	13.00	±1
G	R78.00	±1
H	R25.60	±1
I	R6.50	±1
W1	9.50	±1
W2	12.30	±1