

PTLC05D-B – ESD Protection Diode

Feature

- 450 Watts peak pulse power (8/20 μ s)
- Bidirectional configurations
- Protect one power line
- Solid state silicon-avalanche technology
- Low operating voltage
- Low leakage current
- Low Capacitance: 1.0 pF Typical
- IEC61000-4-2 (ESD) \pm 30 kV (Air), \pm 30 kV (Contact)
- IEC61000-4-4 (EFT) 40A (5/50 ns)
- IEC61000-4-5 (Lightning): 22 A (8/20 μ s)

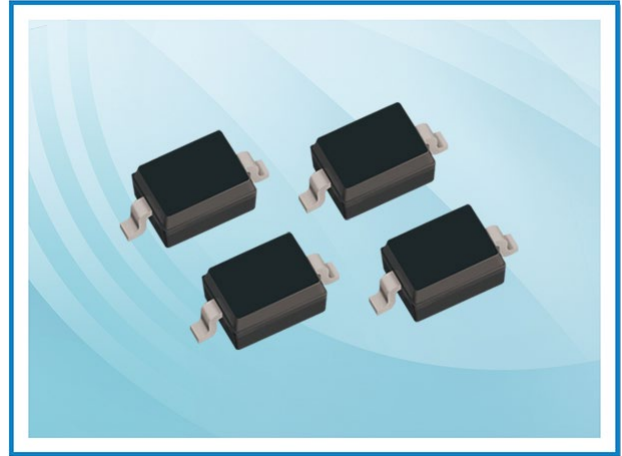

Applications

- Ethernet - 10/100/1000 Base T
- Cellular Phones
- Handheld - Wireless Systems
- Personal Digital Assistant (PDA)
- USB Interface

Mechanical Data

- SOD323 package
- Molding compound flammability rating: UL94 V-0
- Tape and Reel Packaging
- RoHS/WEEE Compliant

Schematic and PIN Configuration

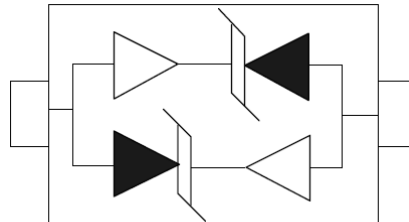

SOD-323

Maximum Rating

Parameter	Symbol	Limit	Unit
IEC61000-4-2 ESD Voltage – Air Mode	$V_{ESD}^{(1)}$	\pm 30	kV
IEC61000-4-2 ESD Voltage – Contact Mode		\pm 30	
Peak Pulse Power	$P_{PP}^{(2)}$	450	W
Peak Pulse Current	$I_{PP}^{(2)}$	22	A
Maximum Lead Solder Temperature (10 seconds duration)	T_L	260	$^{\circ}$ C
Junction Temperature	T_J	-55~150	$^{\circ}$ C
Storage Temperature Range	T_{stg}	-55~150	$^{\circ}$ C

Note:

1. Device stressed with ten non-repetitive ESD pulses.
2. Non-repetitive current pulse 8/20 μ s exponential decay waveform according to IEC61000-4-5.
3. All ratings are measured at environmental temperature of $T_A = 25^{\circ}$ C unless otherwise noted.

PTLC05D-B – ESD Protection Diode

Electrical Characteristics

Parameter	Symbol	Test Conditions	Min	Typ	Max	Unit
Reverse Stand-off Voltage	$V_{RWM}^{(1)}$				5.0	V
Reverse Breakdown Voltage	V_{BR}	$I_T = 1 \text{ mA}$	6.0			V
Reverse Leakage Current	I_R	$V_{RWM} = 5 \text{ V}$			1.0	μA
Clamping Voltage	$V_C^{(2)}$	$I_{PP} = 22 \text{ A}$			20	V
Junction Capacitance	C_J	$V_R = 0 \text{ V}, f = 1 \text{ MHz}$		1.0	1.5	pF

Note:

1. Other voltages available upon request.
2. Non-repetitive current pulse 8/20 μs exponential decay waveform according to IEC61000-4-5.
3. All ratings are measured at environmental temperature of $T_A = 25^\circ\text{C}$ unless otherwise noted.

Electrical Parameters

Symbol	Parameter
V_C	Clamping Voltage @ I_{PP}
I_{PP}	Reverse Peak Pulse Current
V_{BR}	Breakdown Voltage @ I_T
I_T	Test Current
I_R	Reverse Leakage Current @ V_{RWM}
V_{RWM}	Working Peak Reverse Voltage

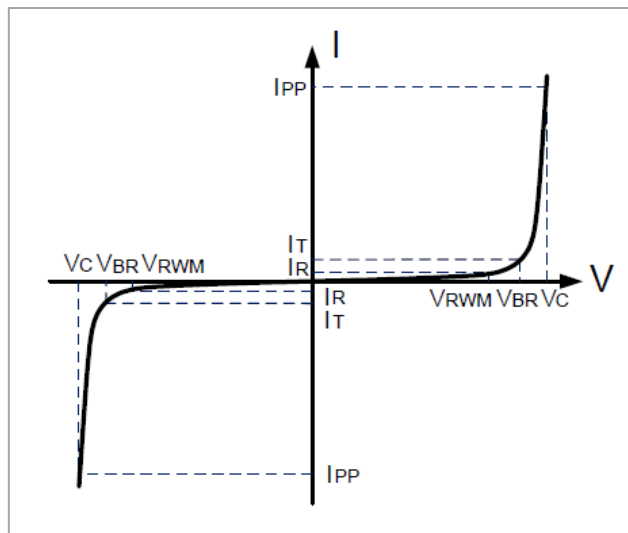

PTLC05D-B – ESD Protection Diode

Typical Characteristics

Figure 1: Peak Pulse Power vs. Pulse Time

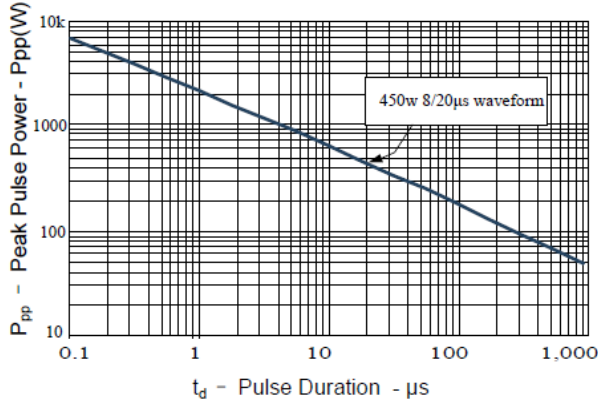

Figure 2: Power Derating Curve

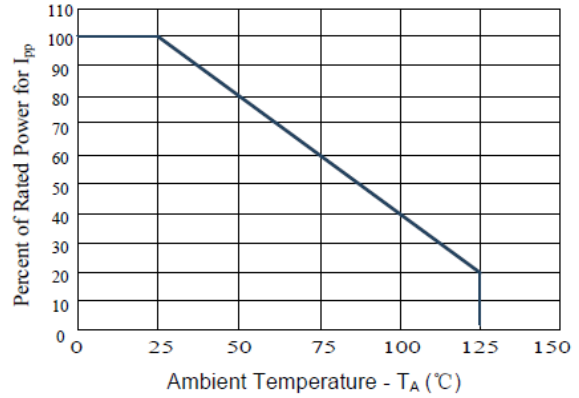

Figure 3: Pulse Waveform

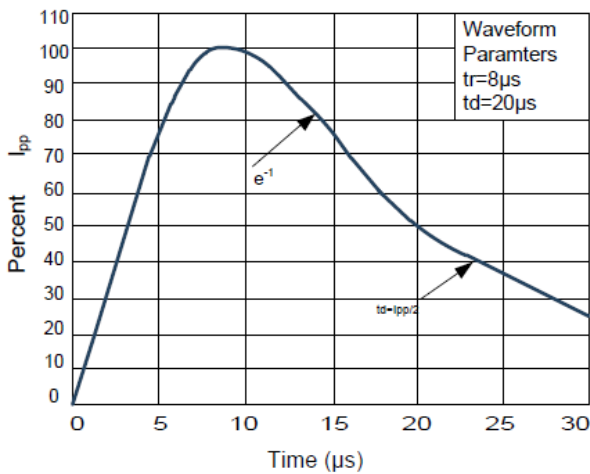

Figure 4: Clamping Voltage vs. Ipp

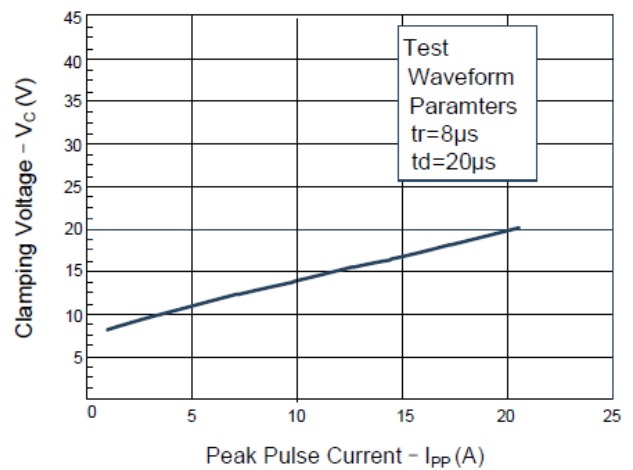

Figure 5: TLP Positive I-V Curve

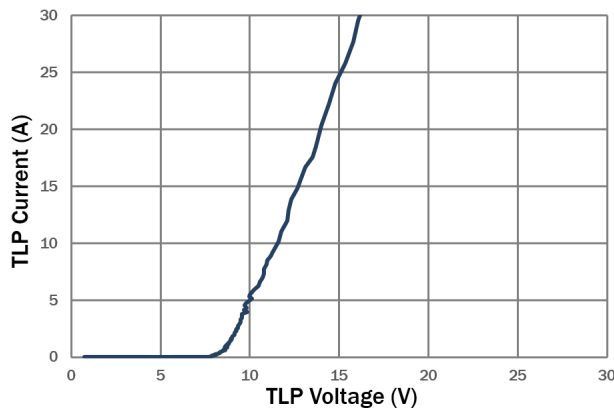
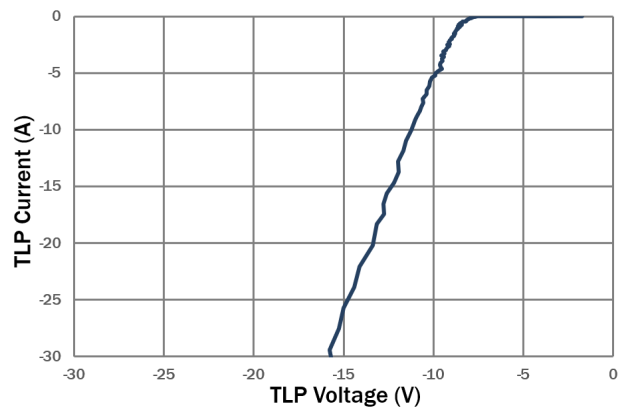
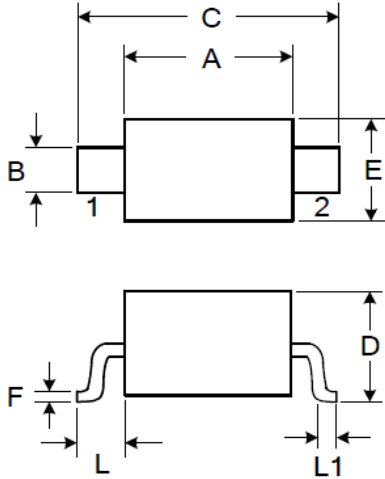

Figure 6: TLP Negative I-V Curve



PTLC05D-B – ESD Protection Diode

SOD323 Package Outline Dimensions



Symbol	Dimensions (mm)	
	Min	Max
A	1.600	1.800
B	0.250	0.350
C	2.500	2.700
D		1.000
E	1.200	1.400
F	0.080	0.150
L	0.475 Ref.	
L1	0.250	0.400
H		0.100

Marking



PTLC05D-B – ESD Protection Diode

Packaging Information

Order Code	Packaging	Reel Size	PCS/Reel
PTLC05D-B	SOD323	7 inch	3,000

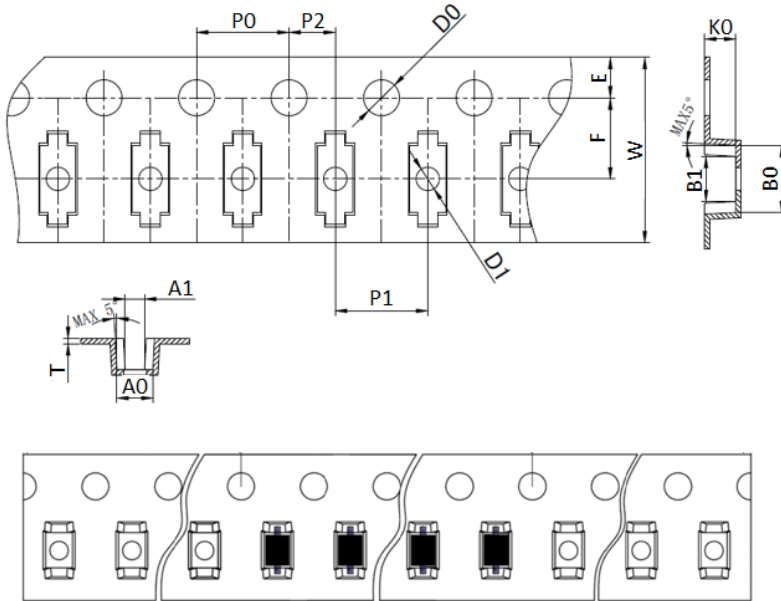

Symbol	Dimension (mm)
A0	1.56±0.10
A1	0.84±0.10
B0	2.90±0.10
B1	1.95±0.10
K0	1.35±0.10
K1	1.15±0.10
P0	4.00±0.10
P1	4.00±0.10
P2	2.00±0.05
T	0.23±0.02
E	1.75±0.10
F	3.50±0.05
D0	1.55±0.05
D1	1.00+0.10/-0
W	8.00+0.30/-0.10

