

PD2D5210105 – Bi-Direction ESD Protection Diode

Description

Design to protect voltage sensitive electronic components from ESD and other transients. Excellent clamping capability, low leakage, low capacitance and fast response time provide best in class protection on designs that are exposed to ESD.

The combination of small size, low capacitance and high level of ESD protection makes them a flexible solution for applications such as HDMI, Display Port TM and MDDI interfaces. It is designed to replace multilayer varistors (MLV) in consumer equipment applications such as mobile phone, notebook, PAD, STB, LCD TV etc.

Marking

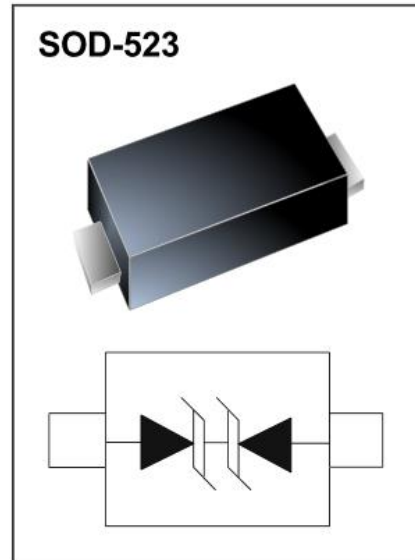

Features

- IEC61000-4-2 (ESD) $\pm 25\text{kV}$ (Air), $\pm 25\text{kV}$ (Contact)
- IEC61000-4-4 (EFT) 40A (5/50ns)
- IEC61000-4-5 (Lightning): 5A (8/20 μs)
- 100 Watts Peak Pulse Power per line ($t_p = 8/20\mu\text{s}$)
- Protects one I/O or power line
- Low clamping voltage
- Working voltage: 5.0V
- Low leakage current

Applications

- Computers and peripherals
- Digital cameras
- Audio and video equipment
- Cellular handsets and accessories
- PDA
- Portable electronics

Maximum Rating

Parameter	Symbol	Limit	Unit
IEC61000-4-2 ESD Voltage – Air Mode	$V_{\text{ESD}}^{(1)}$	± 25	kV
IEC61000-4-2 ESD Voltage – Contact Mode		± 25	
Peak Pulse Power	$P_{\text{PP}}^{(2)}$	100	W
Peak Pulse Current	$I_{\text{PP}}^{(2)}$	5	A
Maximum Lead Solder Temperature (10 seconds duration)	T_L	260	$^{\circ}\text{C}$
Operating Temperature	T_J	-55~125	$^{\circ}\text{C}$
Storage Temperature Range	T_{stg}	-55~150	$^{\circ}\text{C}$

Note:

1. Device stressed with ten non-repetitive ESD pulses.
2. Non-repetitive current pulse 8/20 μs exponential decay waveform according to IEC61000-4-5.
3. All ratings are measured at environmental temperature of $T_A = 25^{\circ}\text{C}$ unless otherwise noted.

PD2D5210105 – Bi-Direction ESD Protection Diode

ESD Standards Compliance

IEC61000-4-2 Standard			
Contact Discharge		Air Discharge	
Level	Test Voltage (kV)	Level	Test Voltage (kV)
1	2	1	2
2	4	2	4
3	6	3	8
4	8	4	15

JESD22-A114-B Standard	
ESD Class	Human Body Discharge Voltage (V)
0	0~249
1A	250~499
1B	500~999
1C	1000~1999
2	2000~3999
3A	4000~7999
3B	8000~15999

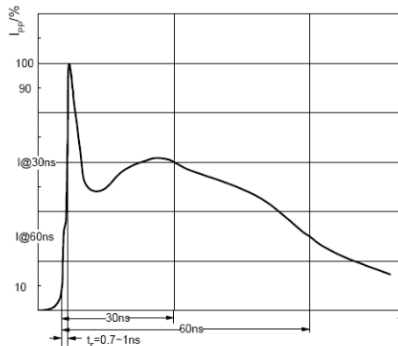

ESD pulse waveform according to IEC61000-4-2

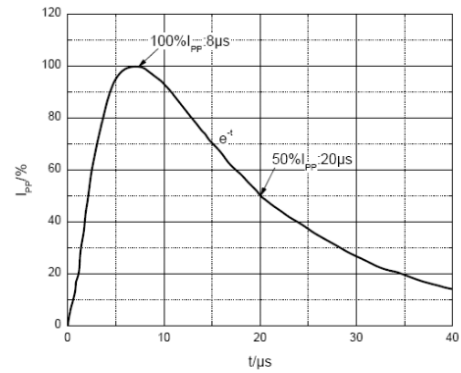

8/20µs pulse waveform according to IEC 61000-4-5

Electrical Parameters

Symbol	Parameter
V _C	Clamping Voltage @ I _{PP}
I _{PP}	Peak Pulse Current
V _{BR}	Breakdown Voltage @ I _T
I _T	Test Current
I _R	Reverse Leakage Current @ V _{RWM}
V _{RWM}	Reverse Stand-off Voltage

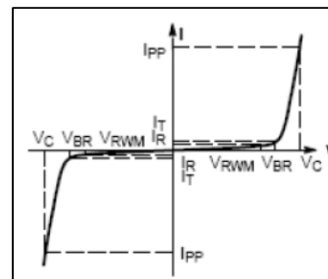

V-I characteristics for a Bi-directional TVS

Electrical Characteristics

Parameter	Symbol	Test Conditions	Min	Typ	Max	Unit
Reverse Stand-off Voltage	V _{RWM} ⁽¹⁾				5.0	V
Reverse Leakage Current	I _R	V _{RWM} = 5V			0.2	µA
Breakdown Voltage	V _{BR}	I _T = 1mA	6.0			V
Clamping Voltage	V _C ⁽²⁾	I _{PP} = 5A		12	15	V
Typical Capacitance	C _J	V _R = 0V, f = 1MHz		5.0	8.0	pF

Note:

- Other voltages available upon request.
- Non-repetitive current pulse 8/20µs exponential decay waveform according to IEC61000-4-5.
- All ratings are measured at environmental temperature of T_A = 25°C unless otherwise noted.

PD2D5210105 – Bi-Direction ESD Protection Diode

Typical Characteristics

Figure 1: Peak Pulse Power Vs Pulse Time

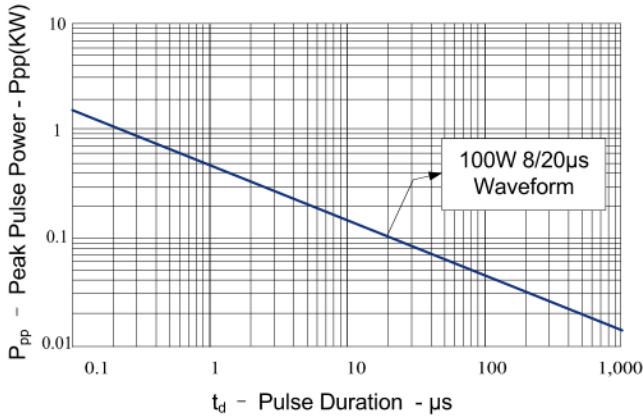

Figure 2: Power Derating Curve

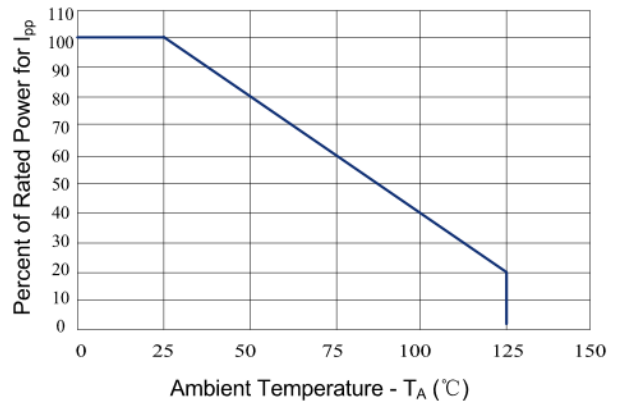

Figure 3: Clamping Voltage vs. Peak Pulse Current

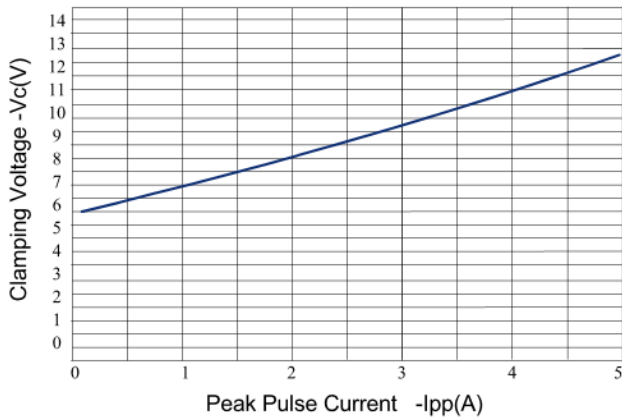

Figure 4: Normalized Junction Capacitance vs. Reverse Voltage

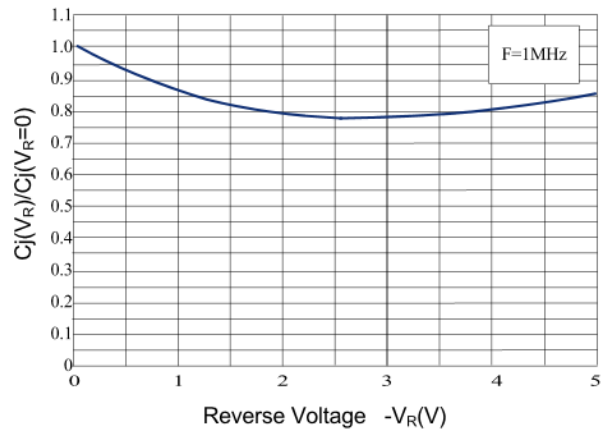

Figure 5: 8/20μs Pulse Waveform

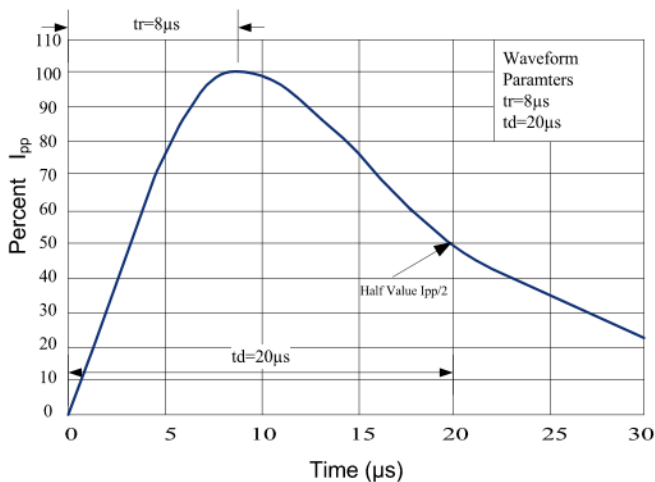
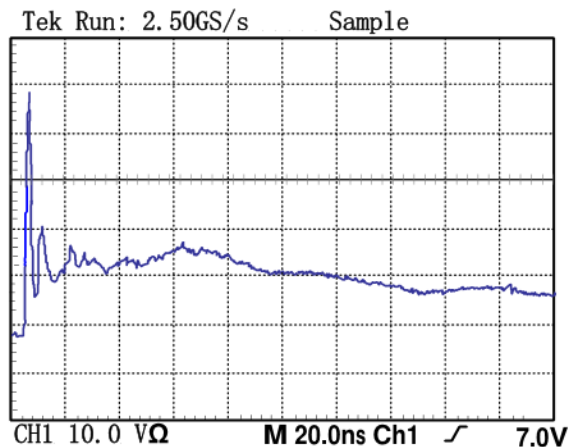
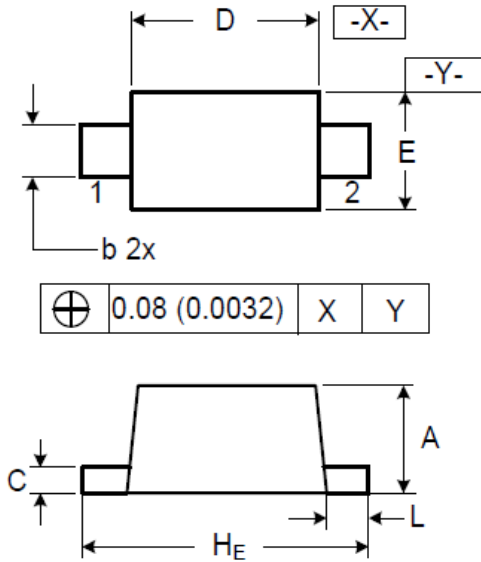

Figure 6: ESD Clamping (8kV Contact per IEC 61000-4-2)



PD2D5210105 – Bi-Direction ESD Protection Diode

SOD-523 Package Outline Dimensions



Symbol	Dimensions (mm)	
	Min	Max
A	0.500	0.700
b	0.250	0.350
C	0.070	0.200
D	1.100	1.300
E	0.700	0.900
H _E	1.500	1.700
L	0.150	0.250

SOD-523 Recommended Pad Layout

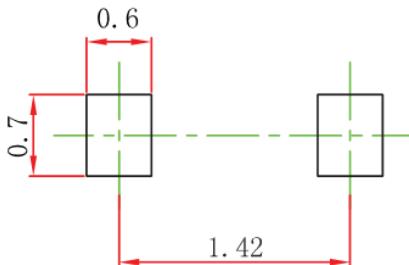

Note:

1. Controlling dimensions in millimeters
2. General tolerance: $\pm 0.05\text{mm}$
3. The pad layout is for reference purpose only

Notice

PTTC reserve the right to make modifications, enhancements, improvements, corrections or other changes without further notice to any product herein. PTTC does not assume any liability arising out of the application or use of any product herein.

PD2D5210105 – Bi-Direction ESD Protection Diode

Tape and Reel Specifications

SOD-523 Embossed Carrier Tape

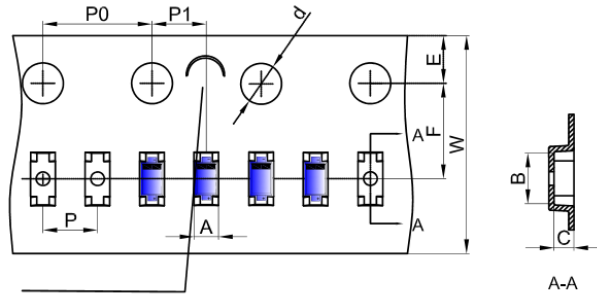

NOTE: TO CAVE 'C' ON CARRIER TAPE PER 120MM

Package Type	A	B	C	d	E	F	P0	P	P1	W
SOD-523	0.9	1.94	0.73	Φ1.50	1.75	3.50	4.00	2.00	2.00	8.00

SOD-523 Reel

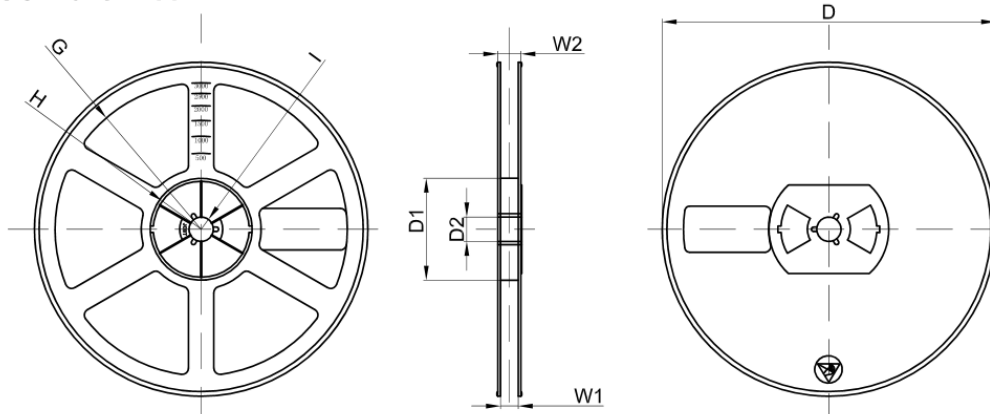

Reel Option	D	D1	D2	G	H	I	W1	W2
7" Dia.	Φ178.0	54.4	13.0	R78.0	R25.6	R6.5	9.5	12.3

*All Dimensions are in millimeters.

Packaging Information

Reel	Reel Size	BOX	Box Size	Carton	Carton Size
5,000 pcs	7 inch				

*All Dimensions are in millimeters.