

PBS08145103 – ESD Protection Diode

Feature

- 450 Watts Peak Pulse Power per Line (tp=8/20μs)
- Protects two line pairs (four lines)
- Low capacitance
- RoHS Compliant
- IEC61000-4-2 (ESD) ±30kV (air), ±30kV (contact)
- IEC61000-4-4 (EFT) 40A (5/50ns)
- IEC61000-4-5 (Lightning): 25A (8/20μs)

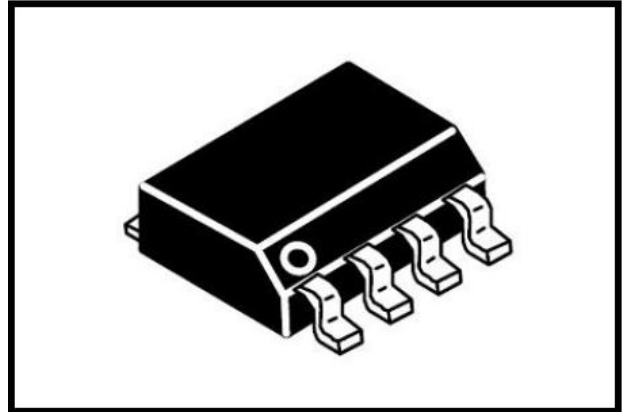

Applications

- 10/100/1000 Ethernet
- WAN/LAN Equipment
- Test & Measurement Equipment
- Switching Systems
- Instrumentation
- Audio/Video Inputs

Mechanical Data

- SOP-08 package
- Molding Compound Flammability Rating: UL94V-0
- Weight 70 Milligrams (Approximate)
- Lead Finish : Lead Free

Schematic and PIN Configuration

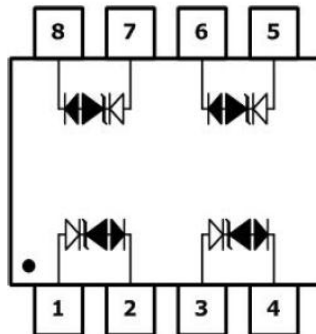

Maximum Rating

Parameter	Symbol	Value	Units
Peak Pulse Power (tp=8/20μs waveform)	P _{PP}	450	Watts
Lead Soldering Temperature	T _L	260(10sec)	°C
Operating Temperature Range	T _J	-55~150	°C
Storage Temperature Range	T _{STG}	-55~150	°C

Note:

1. Device stressed with ten non-repetitive ESD pulses.
2. Non-repetitive current pulse 8/20μs exponential decay waveform according to IEC61000-4-5.
3. All ratings are measured at environmental temperature of T_A = 25°C unless otherwise noted.

PBS08145103 – ESD Protection Diode

Electrical Characteristics

Part Number	Marking	V _{RWM} (V) (Max.)	V _B (V) (Min.)	I _T (mA)	V _C @ 1A (Max.)	V _C		I _R (μA) (Max.)	C _T (pF) (Typ.)
						(V) (Max.)	Test current (A)		
PBS08145103	LC33 04EP8	3.3	3.5	1	5.8	18	25	0.01	2

Note:

1. Other voltages available upon request.
2. Non-repetitive current pulse 8/20μs exponential decay waveform according to IEC61000-4-5.
3. All ratings are measured at environmental temperature of T_A = 25°C unless otherwise noted.

Typical Characteristics

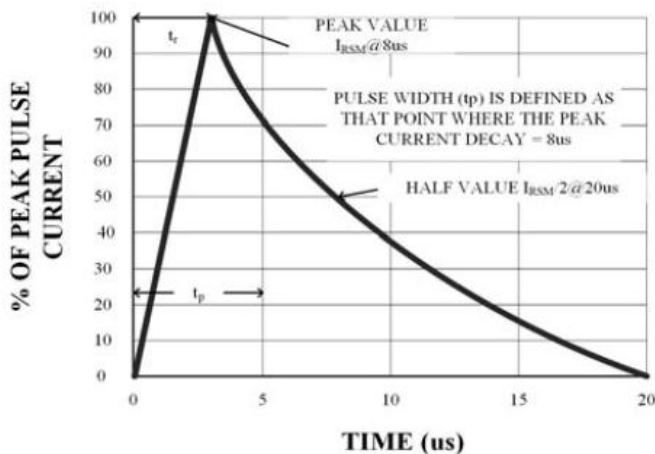
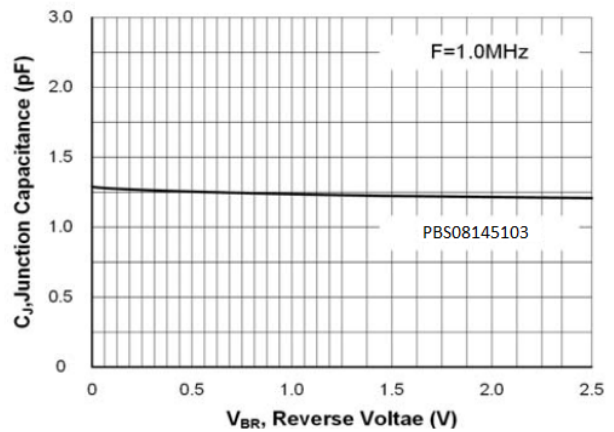
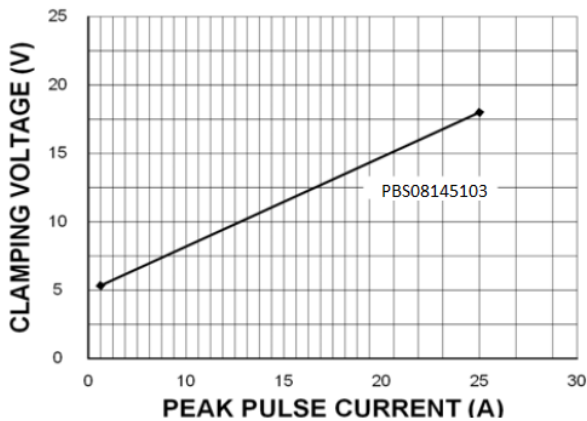

PBS08145103 – ESD Protection Diode

SOP-08 Package Outline Dimensions

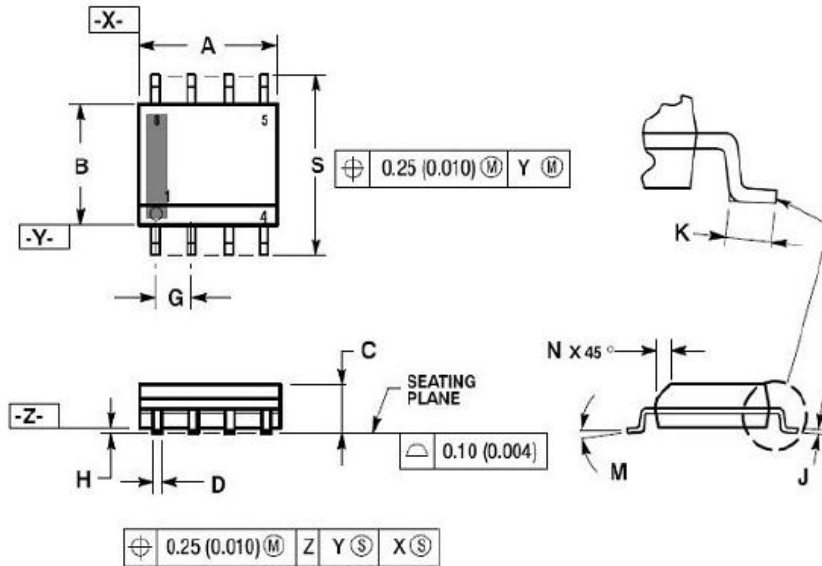

Symbol	Dimensions (mm)	
	Min	Max
A	4.80	5.00
B	3.80	4.00
C	1.35	1.75
D	0.33	0.51
G	1.27 BSC	
H	0.10	0.25
J	0.19	0.25
K	0.40	1.27
M	0°	8°
N	0.25	0.50
S	5.80	6.20

SOLDERING FOOTPRINT

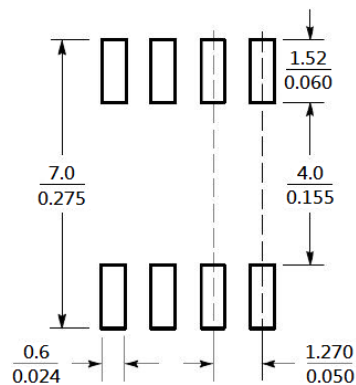

Note: Controlling dimensions in millimeters (inches)

Marking

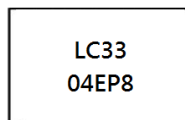

Packaging Information

Order Code	Packaging	Reel Size	PCS/Reel
PBS08145103	SOP-08	13 inch	2,500