

PT712E – ESD Protection Diode

Feature

- 500 Watts peak pulse power (8/20 μ s)
- Bidirectional configurations
- Solid state silicon-avalanche technology
- Low clamping voltage
- Low leakage current
- Protect two data lines
- IEC61000-4-2 (ESD) \pm 30 kV (Air), \pm 30 kV (Contact)
- IEC61000-4-4 (EFT) 40 A (5/50ns)
- IEC61000-4-5 (Lightning): 20 A (8/20 μ s)

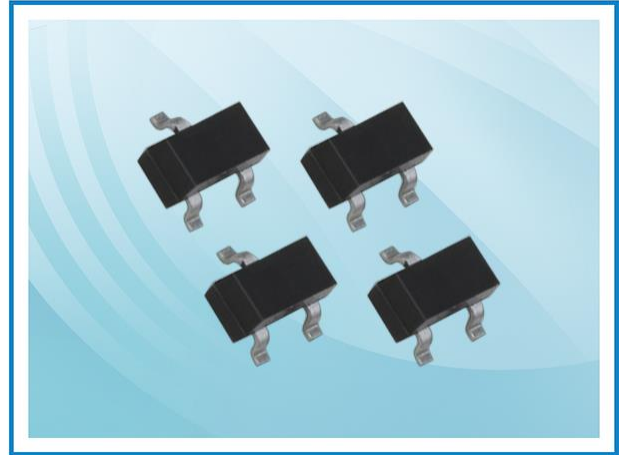

Applications

- Data lines
- Automatic Teller Machine
- Networks
- Power lines

Mechanical Data

- SOT23 package
- Molding compound flammability rating: UL94 V-0
- Tape and Reel Packaging
- RoHS/WEEE Compliant

Schematic and PIN Configuration

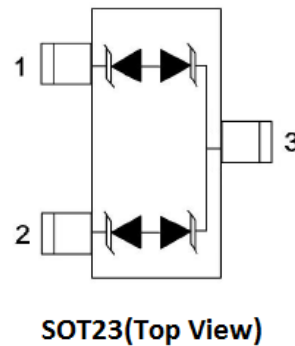
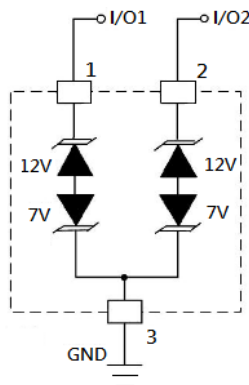

Maximum Rating

Parameter	Symbol	Limit	Unit
IEC61000-4-2 ESD Voltage – Air Mode	$V_{ESD}^{(1)}$	\pm 30	kV
IEC61000-4-2 ESD Voltage – Contact Mode		\pm 30	
Peak Pulse Power	$P_{PP}^{(2)}$	500	W
Peak Pulse Current	$I_{PP}^{(2)}$	20	A
Maximum Lead Solder Temperature (10 seconds duration)	T_L	260	$^{\circ}$ C
Junction Temperature	T_J	-55~125	$^{\circ}$ C
Storage Temperature Range	T_{stg}	-55~125	$^{\circ}$ C

Note:

1. Device stressed with ten non-repetitive ESD pulses.
2. Non-repetitive current pulse 8/20 μ s exponential decay waveform according to IEC61000-4-5.
3. All ratings are measured at environmental temperature of $T_A = 25^{\circ}$ C unless otherwise noted.

PT712E – ESD Protection Diode

Electrical Characteristics

Parameter	Symbol	Test Conditions	Min	Typ	Max	Unit
Reverse Stand-off Voltage	$V_{RWM}^{(1)}$	Pin 1 to 3 and 2 to 3			12	V
		Pin 3 to 1 and 3 to 2			7	V
Reverse Breakdown Voltage	V_{BR}	$I_T = 1\text{mA}$, Pin 1 to 3 and 2 to 3	13.3			V
		$I_T = 1\text{mA}$, Pin 3 to 1 and 3 to 2	8			V
Reverse Leakage Current	I_R	$V_{RWM} = 12\text{V}$, Pin 1 to 3 and 2 to 3			1	μA
		$V_{RWM} = 7\text{V}$, Pin 3 to 1 and 3 to 2			1	μA
Clamping Voltage	$V_C^{(2)}$	$I_{PP} = 20\text{A}$, $t_p = 8/20\mu\text{s}$, Pin 1 to 3 and 2 to 3			26	V
		$I_{PP} = 28\text{A}$, $t_p = 8/20\mu\text{s}$, Pin 3 to 1 and 3 to 2			18	V
Junction Capacitance	C_J	$V_R = 0\text{V}$, $f = 1\text{MHz}$		60	70	pF

Note:

1. Other voltages available upon request.
2. Non-repetitive current pulse 8/20 μs exponential decay waveform according to IEC61000-4-5.
3. All ratings are measured at environmental temperature of $T_A = 25^\circ\text{C}$ unless otherwise noted.

Electrical Parameters

Symbol	Parameter
V_C	Clamping Voltage @ I_{PP}
I_{PP}	Peak Pulse Current
V_{BR}	Breakdown Voltage @ I_T
I_T	Test Current
I_R	Reverse Leakage Current @ V_{RWM}
V_{RWM}	Reverse Stand-off Voltage

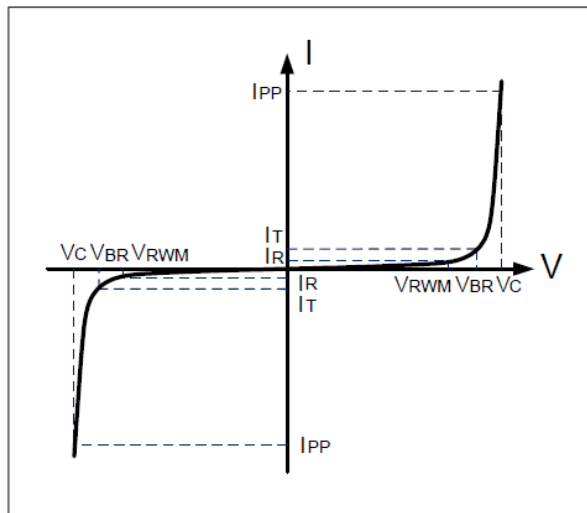

PT712E – ESD Protection Diode

Typical Characteristics

Figure 1: Peak Pulse Power vs. Pulse Time

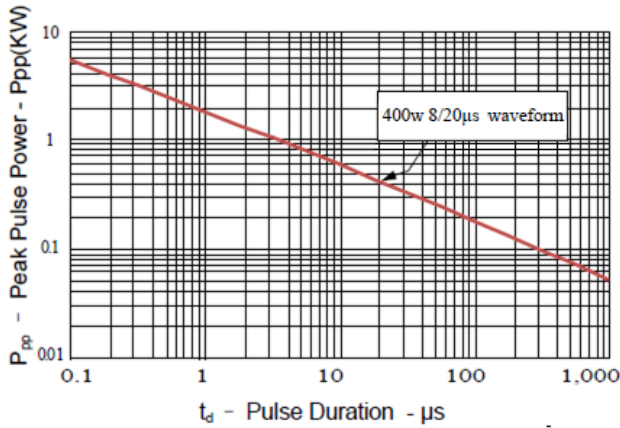

Figure 2: Power Derating Curve

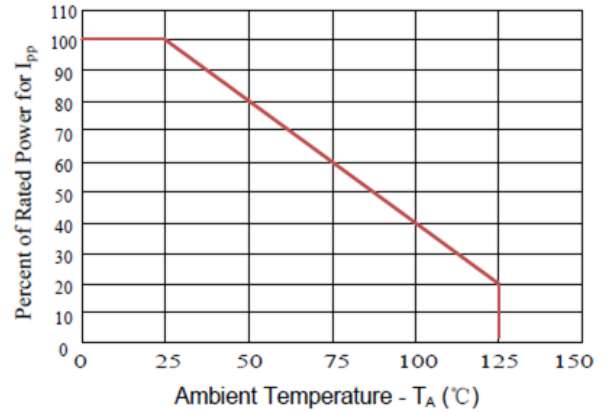

Figure 3: Pulse Waveform

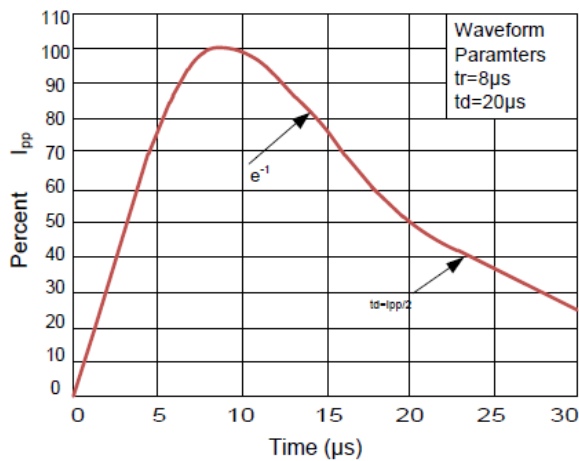
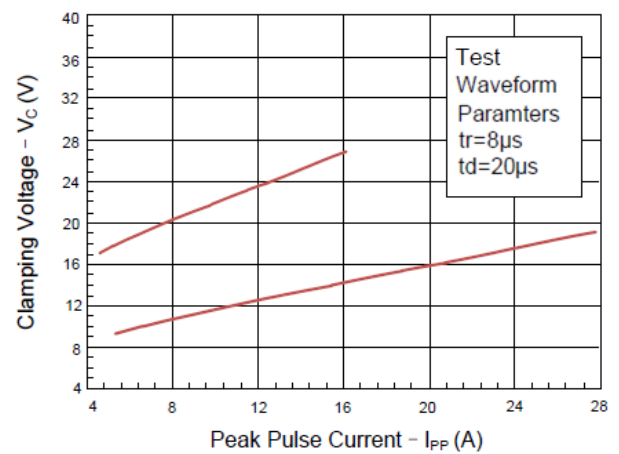
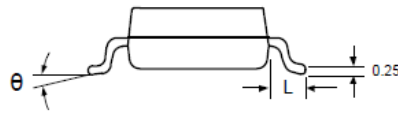
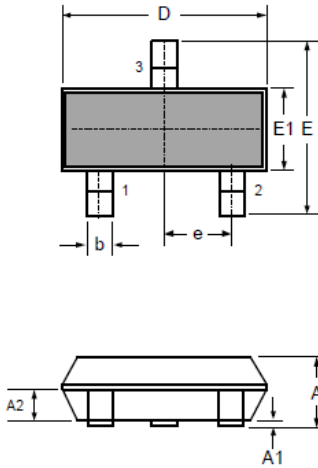

Figure 4: Clamping Voltage vs. Ipp



PT712E – ESD Protection Diode

SOT-23 Package Outline Dimensions



Symbol	Dimensions (mm)	
	Min	Max
A	0.90	1.15
A1	0.00	0.10
A2	0.90	1.05
b	0.30	0.50
D	2.80	3.00
E	2.25	2.55
E1	1.20	1.40
e	0.95 BSC	
L	0.30	0.50
θ	0°	8°

Marking

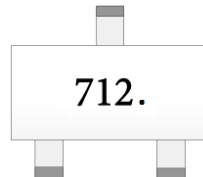

Packaging Information

Order Code	Packaging	Reel Size	PCS/Reel
PT712E	SOT-23	7 inch	3,000