

S23T05C – ESD Protection Diode

Feature

- 400 Watts Peak Pulse Power per Line (tp=8/20 μs)
- Solid-state silicon-avalanche technology
- Bidirectional configurations
- Low leakage current
- Low clamping voltage
- IEC61000-4-2 (ESD) ±30 kV (air), ±30 kV (contact)
- IEC61000-4-4 (EFT) 40 A (5/50 ns)
- IEC 61000-4-5 (Lightning) 22 A (8/20 μs)

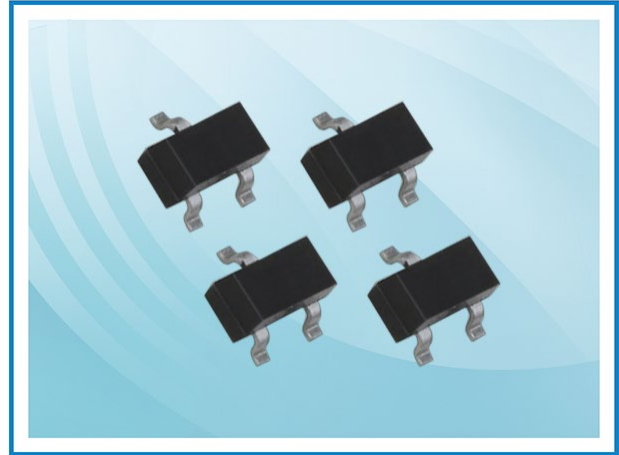

Applications

- Data lines
- Automatic Teller Machines
- Net works
- Power line

Mechanical Data

- SOT-23 package
- Molding compound flammability rating: UL94V-0
- Marking: Marking Code
- Packaging: Tape and Reel
- RoHS Compliant

Schematic and PIN Configuration

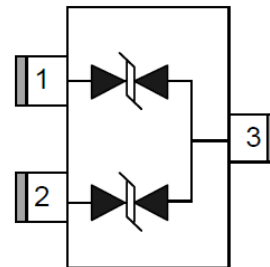
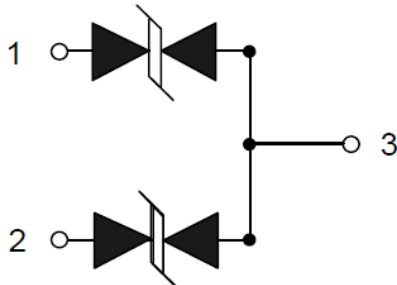

SOT-23 (Top View)

Maximum Rating

Parameter	Symbol	Limit	Unit
IEC61000-4-2 ESD Voltage – Air Mode	$V_{ESD}^{(1)}$	±30	kV
IEC61000-4-2 ESD Voltage – Contact Mode		±30	
Peak Pulse Power	$P_{PP}^{(2)}$	400	W
Peak Pulse Current	I_{PP}	22	A
Maximum Lead Solder Temperature (10 seconds duration)	T_L	260	°C
Junction Temperature	T_J	-55~125	°C
Storage Temperature Range	T_{stg}	-55~125	°C

Note:

1. Device stressed with ten non-repetitive ESD pulses.
2. Non-repetitive current pulse 8/20μs exponential decay waveform according to IEC61000-4-5.
3. All ratings are measured at environmental temperature of TA = 25 °C unless otherwise noted.

S23T05C – ESD Protection Diode

Electrical Characteristics (T=25°C)

Parameter	Symbol	Test Conditions	Min	Typ	Max	Unit
Reverse Stand-off Voltage	$V_{RWM}^{(1)}$				5.0	V
Reverse Breakdown Voltage	V_{BR}	$I_T = 1 \text{ mA}$	6.0			V
Reverse Leakage Current	I_R	$V_{RWM} = 5 \text{ V}$			0.5	μA
Clamping Voltage	V_C	$I_{PP} = 22 \text{ A}$			20	V
Junction Capacitance	C_J	$V_R = 0 \text{ V}, f = 1 \text{ MHz}$		75	90	pF

Note:

1. Other voltages available upon request.
2. Non-repetitive current pulse 8/20 μs exponential decay waveform according to IEC61000-4-5.
3. All ratings are measured at environmental temperature of $T_A = 25^\circ\text{C}$ unless otherwise noted

Electrical Parameters

Symbol	Parameter
I_{PP}	Maximum Reverse Peak Pulse Current
V_C	Clamping Voltage @ I_{PP}
V_{RWM}	Working Peak Reverse Voltage
I_R	Maximum Reverse Leakage Current @ V_{RWM}
V_{BR}	Breakdown Voltage @ I_T
I_T	Test Current

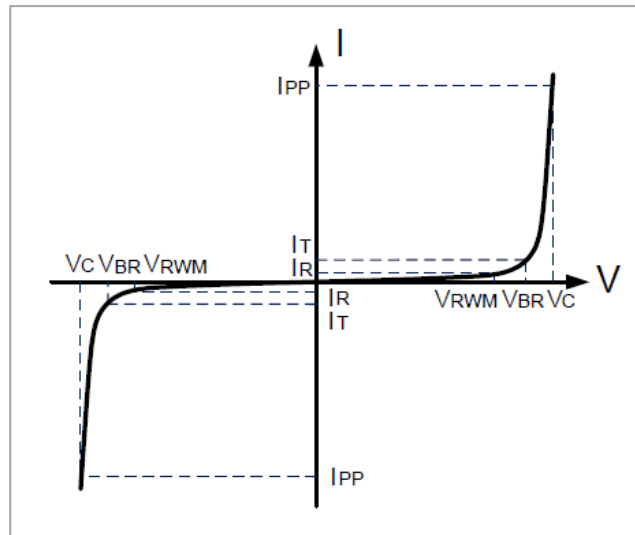

S23T05C – ESD Protection Diode

Typical Characteristics

Figure 1: Peak Pulse Power vs. Pulse Time

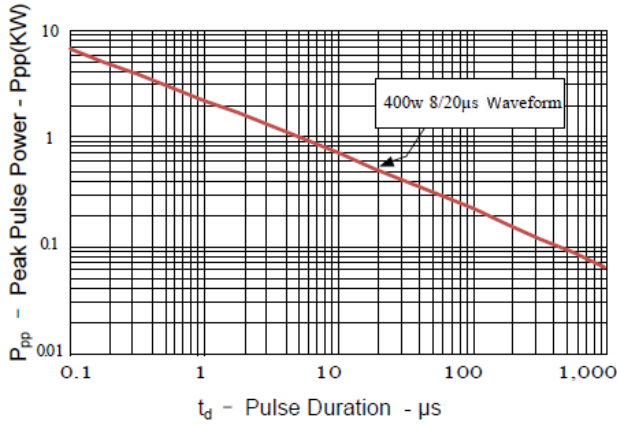

Figure 2: Power Derating Curve

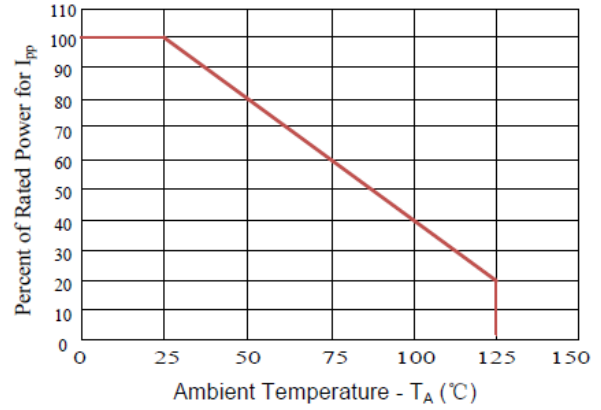

Figure3: Pulse Waveform

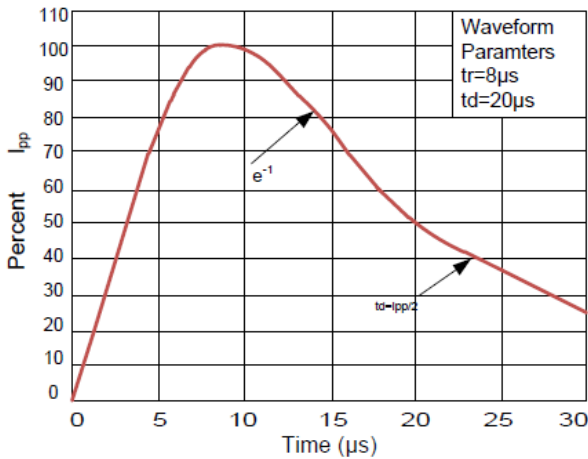

Figure 4: Clamping Voltage vs.Ipp

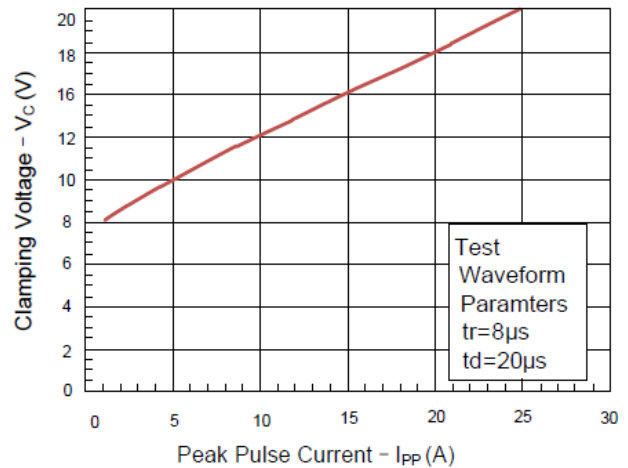

Figure 5: TLP Positive I-V Curve

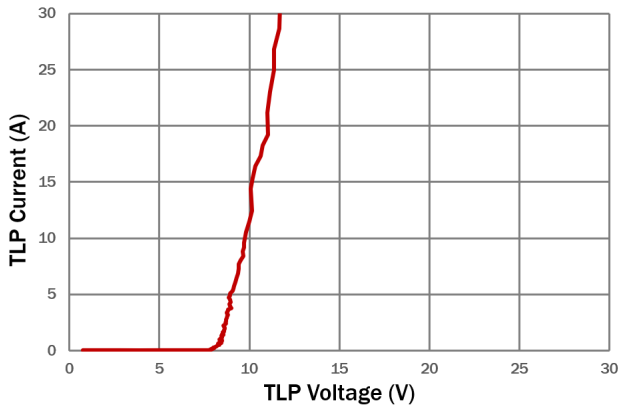
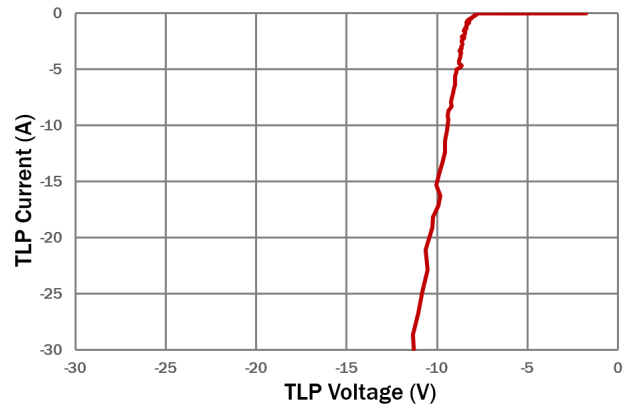
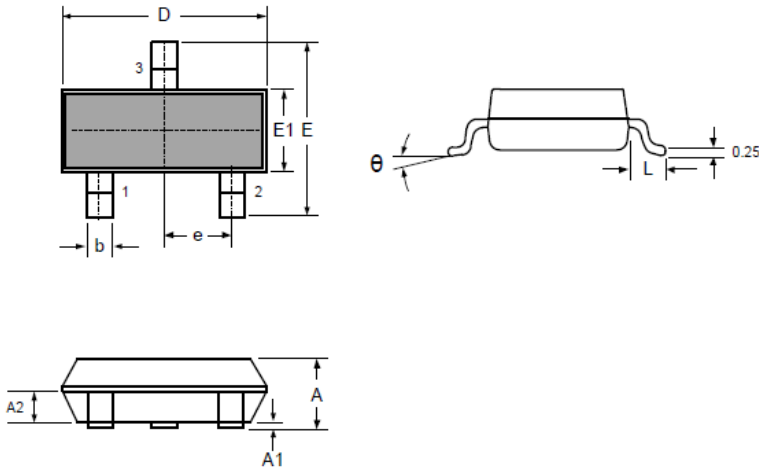

Figure 6: TLP Negative I-V Curve



S23T05C – ESD Protection Diode

SOT-23 Package Outline Dimensions



Symbol	Dimensions (mm)	
	Min	Max
A	0.90	1.15
A1	0.00	0.10
A2	0.90	1.05
b	0.30	0.50
D	2.80	3.00
E	2.25	2.55
E1	1.20	1.40
e	0.95 BSC	
L	0.30	0.50
θ	0°	8°

Marking

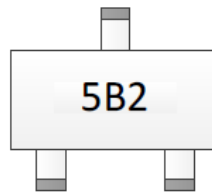

Packaging Information

Order Code	Packaging	Reel Size	PCS/Reel
S23T05C	SOT-23	7 inch	3,000